



OWNER'S MANUAL
ASSEMBLY MANUAL
MONITOR INSTRUCTIONS
WARRANTY & CONTACT INFO

TABLE OF CONTENTS

Owner's Manual	04 - 10
Assembly Instructions	11 - 16
Troubleshooting	17
Monitor Instructions	19 - 25
Warranty Information	26



INTRODUCTION

Congratulations on becoming a WaterRower owner.

Rowing is universally recognized as the perfect aerobic exercise – smooth, low impact, rhythmic and whole-body – unrivalled for its physiological benefits and aesthetic pleasures.

“Rowing, indoors or outdoors, at any exercise level of intensity, requires a greater exercise expenditure than any other aerobic activity. Calories are burned in relation to the number of muscles used and the intensity and duration of the exercise. Rowing with a sliding seat uses a very large muscle mass since the upper, lower and trunk muscles are used vigorously.”

-Dr. C Everett Koop- Former US Surgeon General

While most rowing machines imitate the action of rowing, they do so mechanically, and therefore lack the natural dynamics experienced when a boat and crew glide down a river.

At WaterRower, we have focused on replicating the physical dynamics of rowing, with the knowledge that this will achieve all of its physiological benefits, as well as much of the aesthetic pleasure.

To maximize the enjoyment from using your WaterRower we recommend that you follow our suggestions on rowing technique and training programs. We hope that some of the discussion points in this manual will improve your knowledge about exercise in general, so that you are better able to fulfill your specific exercise objectives.

Your WaterRower has been carefully hand-crafted to give you years of trouble-free use. You will notice that each WaterRower is unique due to the variance in color and grain that occurs naturally in genuine hardwood. We recommend that you closely follow the assembly details provided, particularly by assembling the machine in the correct sequence, and adhering to the suggested maintenance schedule.

We hope you enjoy using your WaterRower for many years to come!

SAFETY

We recommend consulting a physician before starting out with an exercise program.

Please read all instructions before using the WaterRower. Additional information on getting started, rowing technique and rowing training advice can be found at: www.HowToRow.com.

⚠ CAUTION: Please keep hands away from moving parts when rowing machine is in use. Failing to do so can lead to injury. For further information on safety tips, please refer to www.waterrower.com/safety.



OPERATION

The WaterRower is unique in using the effect of drag to provide an exercise which is entirely self paced. Because drag is linked to speed, a crew rowing down a river chooses its intensity of exercise simply by altering the pace at which they row: the faster the boat travels the greater the drag and the harder the crew must work. There is a similar effect in swimming. By replicating these dynamics the WaterRower does not require adjustment to increase resistance: if a more intensive workout is required, simply row faster and harder, and the WaterRower will respond accordingly.

WATER LEVEL

The amount of water in the Tank simulates the weight of the Boat and Crew as it glides down the river. Changing the Water Level does not change the resistance, it simply changes the mass which the user is trying to move. Increasing the Water Level simulates a heavier boat and crew mass, similarly reducing the Water Level simulates a lighter boat and crew mass.

The Water Level is adjusted according to one's personal preference or user type; the intensity is altered simply by moving the chosen mass faster or slower. A level gauge is positioned on the side of the the tank. Overfilling the tank could impact the warranty coverage. Do not fill above the maximum level.

NOTE - Fill the tank with ordinary municipal water. Municipal water contains additives which will deter the growth of algae. If municipal water is unavailable, use distilled water (do not use well water). Unless using blue dye, add the purification tablet supplied with your WaterRower. (For further information, refer to the section on Preventative Maintenance for advice on Water Treatment).

FOOTPAD POSITION

The footpad has been designed to be adjusted for maximum comfort. The foot strap is designed to cross the foot at the pivot point of the toes (the ball of the foot). This should enable the heel to be raised off the footboard as the user comes forward with each stroke. The footpad can be easily adjusted to accommodate different foot positions. The standard footboard model requires pressing the Button between the Foot Straps to move the footpad up or down.

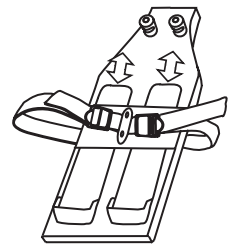

Note: Do not tighten footboard assembly bolts

MAINTENANCE

START UP MAINTENANCE

During the first weeks of use, the wood in your WaterRower will adjust to the temperature and humidity of the environment. During this period it is strongly advised that you GENTLY tighten all the connecting bolts with the Allen key stored under the rear spacer. Please be careful not to overtighten any of these bolts.

Additionally, as the drive and recoil belts loosen up with use, it may be necessary to tighten the bungee cord. To do this, leave the handle in the full forward position and adjust the bungee/recoil belt buckle to provide a little more tension. It may be necessary to tighten to perform these two simple start up procedures once or twice over the first month of use. Please refer to Adjusting the Recoil video at:

www.waterrowerservice.com/videos.

PREVENTATIVE MAINTENANCE

Periodic maintenance is required to maintain the condition of the water in the tank. We strongly ADVISE USING MUNICIPAL TAP WATER which contains treatments to keep it free from bacteria and algae, etc. The water must be refreshed periodically by adding a water purification tablet provided. The purification tablet degrades by exposure to light: this may vary from 6 months in direct sunlight to 2 years in an artificially lit environment. Generally we suggest adding one purification tablet every six months.

If water discoloration occurs, add a purification tablet immediately. If the water does not clear, we recommend emptying the tank, flushing it out with clean water, refilling and adding a purification tablet. NEVER USE POOL CHLORINE OR CHLORINE BLEACH in the tank as this will irreparably damage the polycarbonate tank. The use of an alternative purification option in the tank beyond the approved WaterRower product could void the warranty.

MAINTAINING AND CLEANING

To maintain the appearance and integrity of your WaterRower it is necessary to keep the machine clean. It is particularly important to ensure that there is no dust build up in the clutch and belt mechanism between the top and bottom decks. Dust can be removed by using a cloth or vacuum cleaner.

The surface of the rails must be kept clean to prevent dust and dirt from deteriorating the seat wheels; the rails can be cleaned by wiping with a damp cloth.

The surface of the tank can be cleaned, however, please ensure you read the instructions for any cleaning fluids prior to use.

DO NOT USE METHYLATED SPIRITS, CHLORATES, BLEACH OR AMMONIA BASED FLUIDS WHEN CLEANING ANY PART OF YOUR WATERROWER. The use of improper cleaning products could void the warranty.

MAINTAINING THE WOOD

The natural wood WaterRowers are finished with Danish oil which gives a deep penetrating finish to the hardwood frame. Other than occasional dusting or polishing, the wood requires no maintenance. If you are the owner of an Oxbridge WaterRower, you will notice that Cherry wood is photosensitive and will develop a wonderful dark patina color over time. The use and/or storage of the WaterRower in inclement weather, including but not limited to, extreme temperatures and moisture could void the warranty.

STORAGE OF YOUR WATERROWER

Your WaterRower can be stored upright. Lift the rear spacer end, pull the WaterRower towards you and use the momentum to stand it in an upright position. When storing the WaterRower, please ensure the seat is in the forward position (close to the footboard). When stored upright the WaterRower is stable and it only takes the space of a chair.

USING YOUR WATERROWER

The Rowing Action uses 84% of your muscle mass; from the tips of the fingers holding the handle/oars, to the balls of the feet connected to the footboard/boat, all the muscles between these 2 points contribute to the Rowing Action.

The Rowing Action is comprised of both fast (drive phase) and slow (recovery phase) movements. It is important to combine these 2 movements into a rhythm in order to create a smooth, flowing, unhurried Rowing Action. The diagrams below show 3 basic movements of the rowing action.

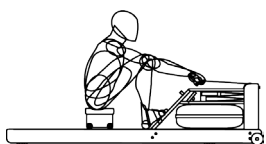

CATCH POSITION

Sitting tall, arms straight reaching forward, shoulders relaxed, head up, eyes looking forward, legs compressed and shins vertical.

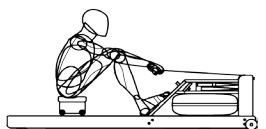

DRIVE PHASE

Drive back with the legs, arms hang off the handle and only begin to bend once handle is above the knees, torso is strong with good posture and body angle opens up slowly as you drive the legs.

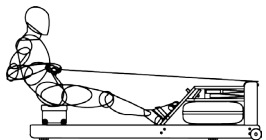

RELEASE POSITION

Legs straight, handle drawn to chest, sitting back just past the vertical, torso firm, shoulders relaxed, head up and eyes looking forward.

Allow yourself the first few rowing sessions to practice the correct positions and phases as well as the correct ratio and rhythm of the rowing action. With regular rowing, the technique will become easier and you will soon experience the physiological benefits of rowing.

Please visit www.HowToRow.com to learn more about the phases and positions of the rowing technique.

YOUR EXERCISE PROGRAM

Most of us recognize the benefit of exercise and the potential improvements to our general health and well-being. However, few of us fully understand the physiology of exercise and the best means of achieving our specific exercise objectives.

In order to get the most out of any exercise program, it is essential to have an understanding of what your exercise objectives are. These may include reducing or maintaining weight, improving general strength, developing bulging muscles, improving sporting competitiveness or simply avoiding the health consequences of a modern sedentary lifestyle.

It is important to set a few different types of objectives.

These are divided into:

- Immediate Objectives - weekly
- Short Term Objectives - monthly
- Long Term Objectives - yearly

Your long term objectives are your final objectives, to achieve these, you need stepping stones which are the short term objectives and immediate objectives. Objectives need to be:

- Specific - set goals that you would like to achieve by certain dates
- Realistic - do not set a standard too high or motivation will be lost
- Flexible - be prepared for set backs such as injuries and illness

WEIGHT MAINTENANCE

At lower intensities, our body uses a mixture of fat and carbohydrate as its source of fuel. As the maximum aerobic output is approached, the percentage of fat consumed as fuel reduces to zero. Also, as the duration of exercise is increased, the percentage of fat consumed tends to increase.

If your objective is weight maintenance, then the energy (food) you consume must equal energy used (exercise, metabolism etc.). Exercising for weight maintenance is best achieved at lower intensities and over longer durations. A low intensity (60 - 70% of the maximum heart rate) is typically that at which you can hold a conversation; it is by no means strenuous and is about that achieved by a brisk walk.

AEROBIC TRAINING

A sustained exercise program will improve the efficiency with which the respiratory and cardiovascular system can supply oxygen. This improves lung function, heart function, vascular efficiency and capillary growth, leading to improved well-being and endurance. At about 70 - 80% of the maximum heart rate, lactic acid begins to accumulate in the blood supply at a greater rate than it can be extracted by the liver, kidneys and other organs. Exercising above this intensity will cause progressive accumulation of lactic acid in the blood, increased heart and breathing rates and cause muscle fatigue.

Prolonged exercise at or below this intensity will maintain lactic acid at non-fatiguing levels and exercise duration will be limited solely to the depletion of available fuel stores. If your exercise objective is aerobic training (cardiovascular/endurance), then it is necessary to exercise at an intensity which will avoid fatigue due to lactic acid build up. This is best achieved at moderate levels of intensity over medium/long durations.

A moderate exercise intensity (70-80% of the maximum heart rate) is about that achieved by a steady jog, avoiding the onset of muscle soreness.

ANAEROBIC TRAINING

Anaerobic training causes the build-up of lactic acid (as rapidly as one minute after exercise is commenced). Lactic acid saturation will necessitate either a rapid reduction in exercise intensity or complete cessation.

The accumulation of lactic acid limits the contribution of the anaerobic process to total energy production. Though energy may be generated rapidly, total work capacity and total output is limited.

The level of intensity at which lactic acid begins to accumulate can be altered by training. This is best done by improving the efficiency of the aerobic process and is achieved by training at moderate levels of intensity.

Exercising at anaerobic intensities may condition an athlete's tolerance to fatigue, but the benefit can be more psychological than physiological. Prolonged exercise at high intensity not only impairs the weight reduction and aerobic training effect, but the rapid onset of fatigue can cause poor technique and increase risk of injury.

Training anaerobically is done at high intensities (80-100% of the maximum heart rate) over a short period of time (10 seconds to a few minutes). Interval training is a form of anaerobic training.

TRAINING GUIDELINES

To ensure you get the maximum benefit from training on your WaterRower and to avoid unnecessary problems or injuries here are a few guidelines:

- A health check before starting an exercise program.
- Use heart rate to monitor your intensity.
- Always warm up and cool down.
- Always stretch, especially at the end of your workout.
- Keep a record of your workouts.
- Keep well hydrated.
- Gradually increase the intensity, duration and frequency of your workouts.
- Ensure you include recovery time in your training program.
- Add variety to your workouts. (refer to HowToRow.com/workouts)

WATERCOACH

WaterCoach is a rowing education program designed to broaden the knowledge of rowing as a fitness pursuit. WaterCoach consists of three programs for the WaterRower owner, fitness professional/instructor and the general rowing machine user in the gym;

- WaterCoach Home - a rowing education program and personal training advice for the WaterRower owner.
- WaterCoach Professional - a rowing education program for the fitness professional/instructor. ACE certified course.
- HowToRow - a rowing education program for the rowing machine user, at a gym.

We hope that this expanded knowledge enables you to realize the unrivalled physical benefits of rowing and get the best from your WaterRower. For more information, please visit **www.HowToRow.com**.

TRAINING RESOURCES

For further information on your exercise objectives and rowing training types please visit **www.HowToRow.com**.

We have done our best to keep the assembly instructions as clear and concise as possible. Assembling your WaterRower takes about 30-45 minutes and the only tool you need is a 5mm Allen Key that is included on the rear spacer or in the assembly bag. The WaterRower comes partially assembled in two boxes.

PLEASE READ INSTRUCTIONS FULLY BEFORE STARTING ASSEMBLY

COMPONENTS

Main Parts

- A Rails* x 2
- B Rear Spacer* with Bungee
- C Seat*
- D Footboard*
- E Tank Assembly* (with S4 monitor)

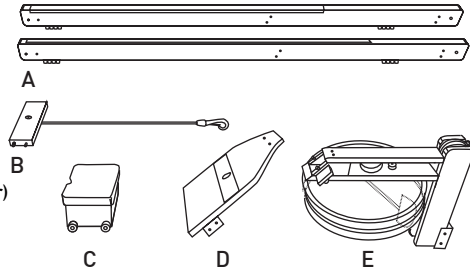

Other Parts

- F Dolly Wheel Assembly (WRP-D100) x 2
- G JCB (WRB-B711) x 8
- H JCN (WRP-B700) x 12
(4 are pre-installed on Rear Spacer)
- I Handle Rest (WRP-P430) x 2
- J Handle Rest Bolt (WRP-P455) x 2
- K 5mm Allen Key (WRP-B740) x 2
- L Footpads (WRP-P700) x 2
- M Syphon Pump (WRP-B405) x 1
- N Purification Tablets (WRP-B960) x 2

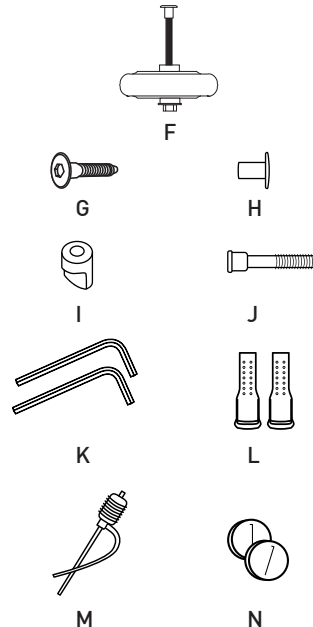

*NOTE: Items marked above contain parts made from genuine hardwood. Color and grain variances are part of the uniqueness of this product that is made from organic (not machine made) materials.

STEP 1

Lay the rails on the floor and connect the rear spacer using the female JCN nuts and the Allen keys provided.

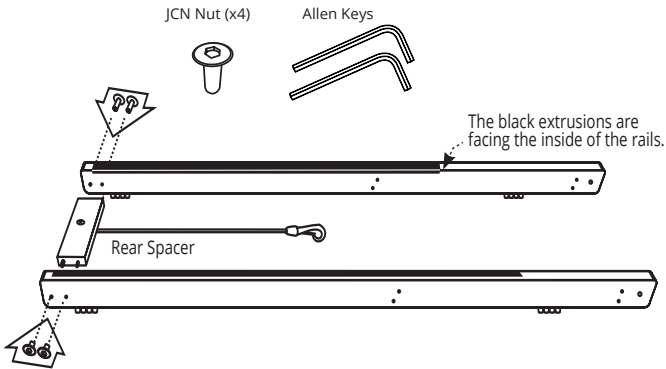

STEP 2

Place the seat assembly between the rails with the indent facing towards the rear spacer. The larger vertically mounted wheels (the load wheels) should sit on the plastic extrusions on the top of the rail. The smaller horizontal wheels below the seat (the guide wheels) should sit between the rails. It may be necessary to separate the rails slightly to allow the guide wheels to fit down between the rails.

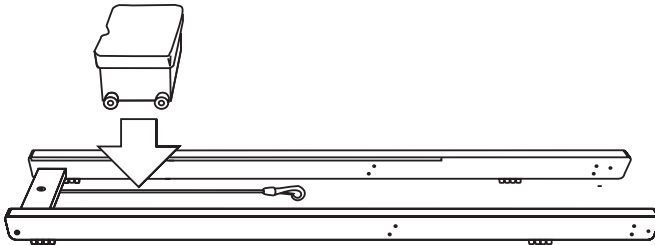

STEP 3

Place the tank assembly between the rails.

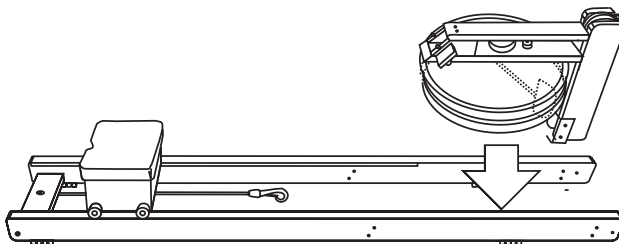

STEP 4

Insert the JCN Nuts and JCB Bolts attaching the tank to the rails at locations A & B. The nuts should be placed on the inside and the bolts on the outside.

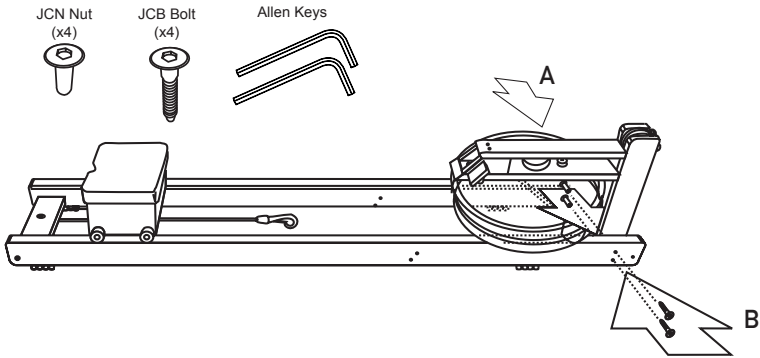

STEP 5

Place the footboard between the rails positioning the top two holes over the two threaded holes in the tank unit. It may be necessary to slightly loosen the two bolts on the Top Deck (B) to allow the footboard clearance. Insert the JCN Nuts and JCB Bolts attaching the Footboard to the Rails at A. Screw the Handle Rests into position using the Handle Rest Bolts (C); do not over tighten.

*Should you experience any problem with aligning the components, loosen all the fasteners, align and re-tighten.

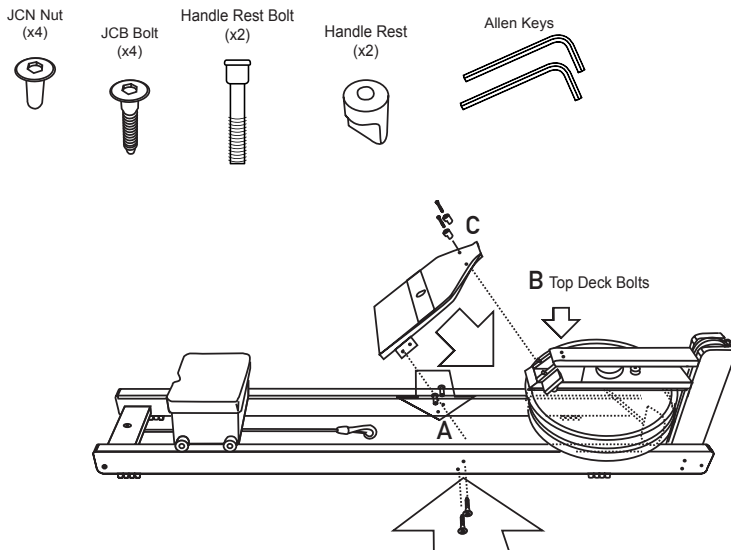

STEP 6

Press the heelrest adjustment button (A) and insert the heelrest/footpads under the footboard cover plate (B). Release the button to 'lock' the heelrests into place. You can adjust the height of the heelrests according to your foot size (refer to the Owner's Manual).

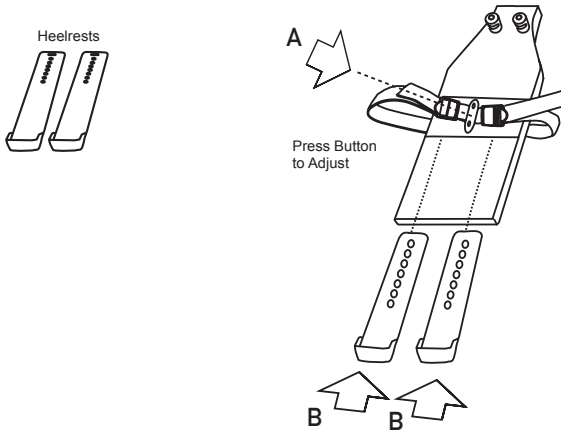

STEP 7

Undo the Dolly Wheel Assembly and fix to the rail in the order shown and tighten. Note - the wheel goes on the outside of the Rail.

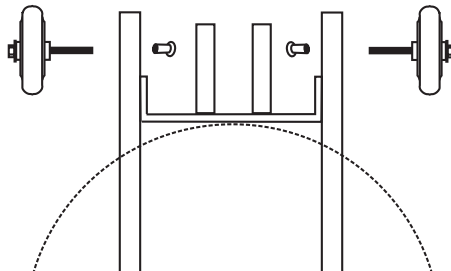

STEP 8

Stand the WaterRower upright. Release the recoil belt (which is wrapped around the bracket at the base of the machine). Ensure that the recoil belt is passing over all guide pulleys. Connect the bungee to the recoil strap by hooking the bungee hook through the recoil belt D-ring.

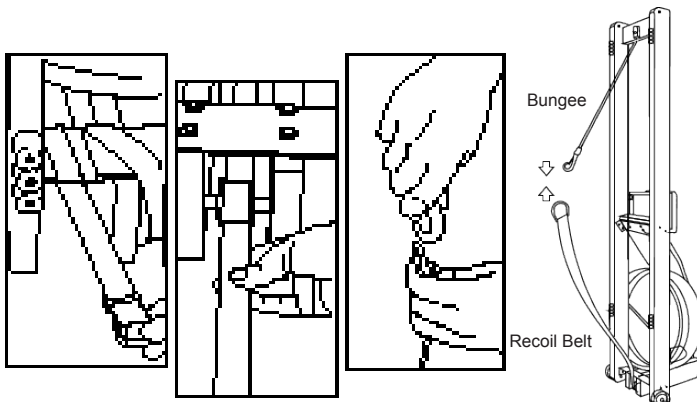

STEP 9

Before filling the tank and rowing, ensure that the recoil belt passes smoothly over all pulleys.

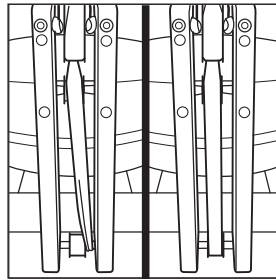

Misaligned Aligned

STEP 10

Lay the unit flat and remove the tank stopper from between the top and bottom deck. Use the included syphon pump (or a hose if available) to fill the tank to the desired level with municipal water.

Insert one purification tablet (provided) now and every six months. Additional purification tablets are available upon request at: www.waterrowerservice.com/puritabs

Once completed, insert the Tank Stopper; it may be necessary to moisten the Stopper to assist with replacement.

- ▶ Please wipe excess water from wooden components after filling

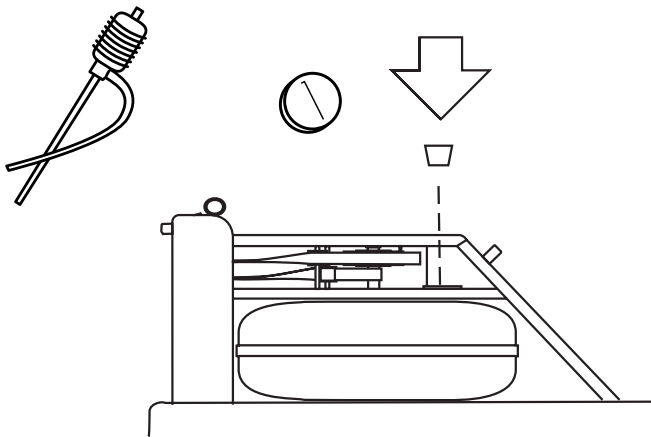

HOW TO FILL AND EMPTY THE TANK

- 1) To pump water, turn the knob clockwise to close valve as shown in figure A
- 2) Locate water source above (higher than) water destination:
 - See Figure B for filling tank
 - See Figure C for emptying tank
- 3) Squeeze pump 4-5 times until water flows
- 4) Turn knob counter-clockwise to allow air into the pump and end syphon.

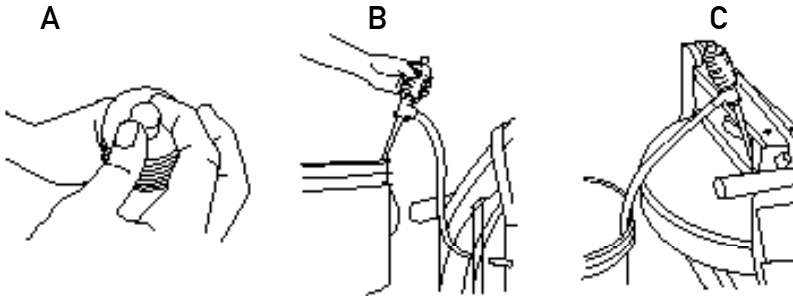

WATER LEVEL

The Level Gauge is positioned on the side of the tank. Information on the sticker includes WaterRower contact information and the Water Level Gauge. The maximum level to fill the tank is Level 19. **DO NOT** fill above the maximum level - this could void the warranty. The standard Calibration Level is Level 17.

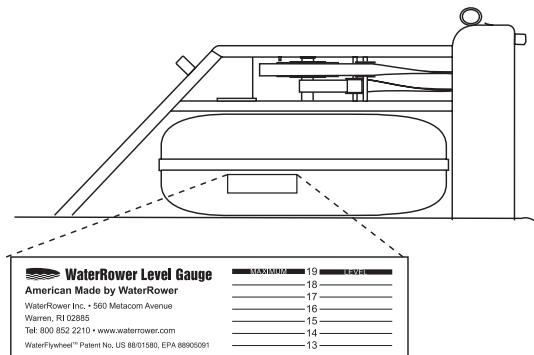

TROUBLESHOOTING

1. Monitor flashing zeros

Solution 1: Try raising the sensor disk (located on top of the clutch). During shipment, the disk may have shifted.

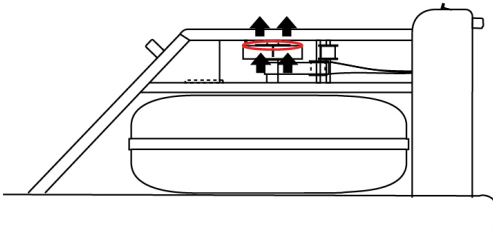

Solution 2: Loosen and retighten the bolts on the upper deck and forward riser. If these bolts are not uniformly tightened during assembly, the alignment may be off.

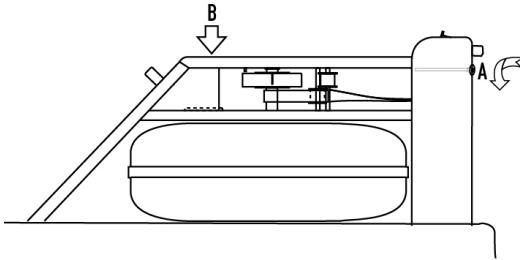

- 2. Loosening bolts** - over time and with use bolts can come loose. Use the 5mm Allen key to gently tighten the bolts. If the bolts continue to loosen use a small amount of medium strength Loctite® to fasten the nuts and bolts more securely.
- 3. Monitor not turning on** - check the batteries positioned behind the monitor. Unscrew the monitor and gently lift to access the battery pack.
- 4. Monitor not counting down** - check that the monitor and sensor connector are connected. Check all wiring is intact.
- 5. Paddle not turning smoothly** - Loosen all tank bolts and retighten. See instructions at:
http://www.waterrowerservice.com/pdfs/troubleshooting_all_rubbing_tank.pdf

**For other troubleshooting and service tips, please visit:
www.waterrowerservice.com/troubleshooting
or contact WaterRower at support@waterrower.com**

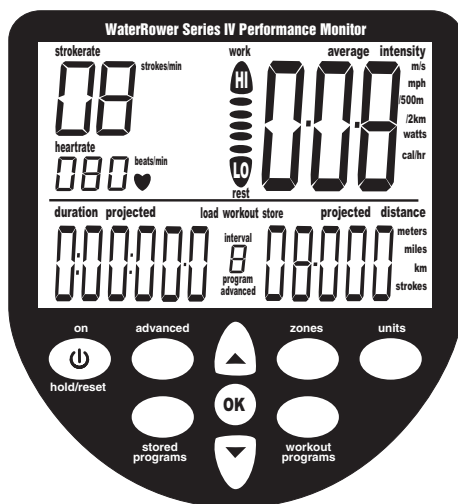

The WaterRower S4 Performance Monitor has been designed to balance a high level of technical sophistication with user friendliness.

The WaterRower S4 Monitor consists of the following information buttons and windows (see the following pages for specific details about each button and window):

BUTTONS

On/Hold/Reset Button

Press the ON button to start up the monitor: the units will flash ready to count down as you begin rowing. To reset the monitor, press the ON button for 2 seconds.

Programming Buttons

Zones, Workout Programs, Advanced, Stored Programs

Navigation/Select/Display Information Buttons

Up, Down, OK, Units

WINDOWS

Information/Programming Windows

Strokerate, Heart Rate, Duration, Intensity, Average Intensity, Distance

These Information and Programming Windows show your current and programmed workout details.

Zone Bar Window

Seen in the top middle part of the screen, the Zone Hi / Zone Lo bars are used during zone, interval and advanced workouts. They will flash and emit a high frequency tone when your Hi or Lo limit is breached.

Stored Workout, Interval Number, Advanced Program Number

Seen in the bottom middle part of the screen, this window displays numbers to navigate through numbered or sequenced information (stored workouts, intervals and advanced programs).

NOTE: The WaterRower S4 Monitor automatically powers off after 2 minutes of no use.

INFORMATION AND PROGRAMMING WINDOWS

The WaterRower S4 Monitor has 6 main information windows that will display when the monitor is in use:

- A. Strokerate**
- B. Heart Rate**
- C. Duration**
- D. Intensity**
- E. Average Intensity**
- F. Distance**

See the chart below for the full description on each information window, as well as how to select desired units.

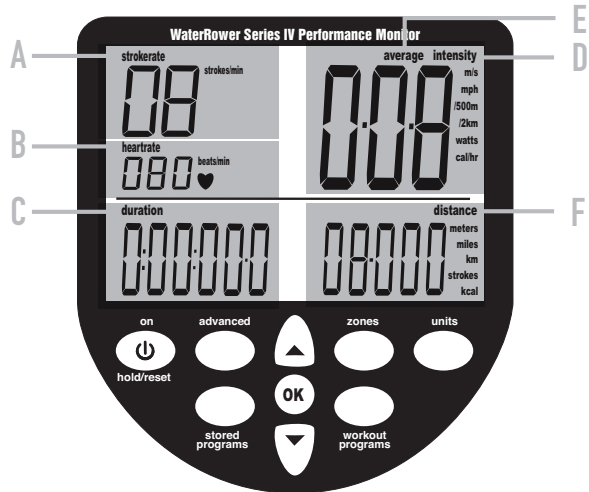

PRIMARY INFORMATION DISPLAYED ON THE S4 MONITOR

A - STROKERATE	
Displays the number of strokes rowed per minute.	
B - HEART RATE	
Displays current heart rate (requires optional heart rate receiver and transmitter).	
C - DURATION	
Displays time in: HOURS, MINUTES, SECONDS, DECIMAL SECONDS	
D - INTENSITY	
Displays <u>SPEED/POWER/ENERGY</u> : <ul style="list-style-type: none"> • M/s - METERS PER SECOND • MPH - MILES PER HOUR • /500M - MINUTES PER 500 METERS • /2KM - MINUTES PER 2 KILOMETERS • WATTS - WATTS • CAL/HR - CALORIES BURNT PER HOUR 	To select desired intensity unit: <ol style="list-style-type: none"> 1. Press UNITS one (1) time. 2. Use ARROW buttons to scroll to the desired intensity unit. 3. Press OK to select.
E - AVERAGE INTENSITY	
Displays <u>AVERAGE SPEED</u> : <ul style="list-style-type: none"> • M/s - METERS PER SECOND • MPH - MILES PER HOUR • /500M - MINUTES PER 500 METERS • /2KM - MINUTES PER 2 KILOMETERS 	To select desired average intensity unit: <ol style="list-style-type: none"> 1. Press UNITS two (2) times. 2. Use ARROW buttons to scroll to the desired intensity unit. 3. Press OK to select.
F - DISTANCE	
Displays <u>DISTANCE</u> in: <ul style="list-style-type: none"> • METERS • MILES • KILOMETERS (KM) • STROKES • CALORIES (KCAL) 	To select desired distance unit: <ol style="list-style-type: none"> 1. Press UNITS three (3) times. 2. Use ARROW buttons to scroll to the desired distance unit. 3. Press OK to select.

WORKOUT PROGRAMS BUTTON

DISTANCE WORKOUT		
	<ol style="list-style-type: none"> 1. Press the Workout Programs button <i>one (1) time</i>. 2. Using the Arrows, scroll to the desired workout <i>distance</i>. 3. Press OK; Row. 	
DURATION WORKOUT		
	<ol style="list-style-type: none"> 1. Press the Workout Programs button <i>two (2) times</i>. 2. Using the Arrows, scroll to the desired workout <i>duration</i>. 3. Press OK; Row. 	
INTERVAL WORKOUT - DISTANCE		
		<ol style="list-style-type: none"> 1. Press the Workout Programs button <i>three (3) times</i>. 2. Using the Arrows, scroll to the desired <i>interval one (1) distance</i>. 3. Press OK. 4. Using the Arrows, scroll to the desired <i>interval one (1) recovery duration*</i>. 5. Press OK. 6. Repeat steps 2-5 (up to 9 distance intervals may be entered). 7. Press OK two (2) times to end sequence; Row.
Interval 1 Workout Distance	Interval 1 Recovery Duration*	
INTERVAL WORKOUT - DURATION		
		<ol style="list-style-type: none"> 1. Press the Workout Programs button <i>four (4) times</i>. 2. Using the Arrows, scroll to the desired <i>interval one (1) workout duration</i>. 3. Press OK. 4. Using the Arrows, scroll to the desired <i>interval one (1) recovery duration*</i>. 5. Press OK. 6. Repeat steps 2-5 (up to 9 duration intervals may be entered). 7. Press OK two (2) times to end sequence; Row.
Interval 1 Workout Duration	Interval 1 Recovery Duration*	

*RECOVERY DURATION OF LESS THAN 2 MINUTES MUST BE SET OR MONITOR WILL POWER OFF

ZONES BUTTON

Zone setting allows the user to set upper (hi) and lower (lo) limits for *heart rate*, *intensity* and *strokerate*.

- When the set **zone lo** limit is breached the zone bar lo flag will flash and a low frequency tone will emit.
- When the set **zone hi** limit is breached the zone bar hi flag will flash and a high frequency tone will emit.
- When operating between the upper and lower zone limits, the position in this range will be displayed by the divisional zone bars.

HEART RATE ZONE SETTING

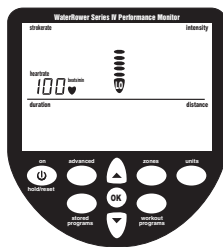
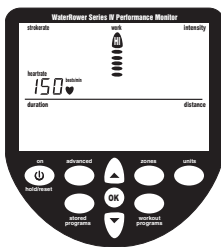

1. Press the **Zones** button *one (1) time*.
2. Using the **Arrows**, scroll to the desired *upper limit*.
3. Press **OK**.
4. Using the **Arrows**, scroll to the desired *lower limit*.
5. Press **OK**; Row.

INTENSITY ZONE SETTING

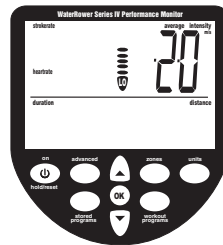
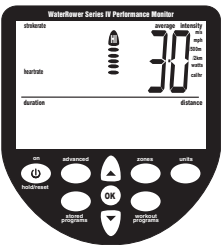

1. Press the **Zones** button *two (2) times*.
2. Using the **Arrows**, scroll to the desired *upper limit*.
3. Press **OK**.
4. Using the **Arrows**, scroll to the desired *lower limit*.
5. Press **OK**; Row.

STROKERATE ZONE SETTING

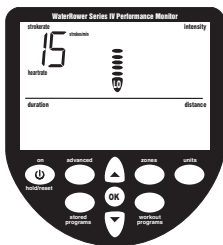
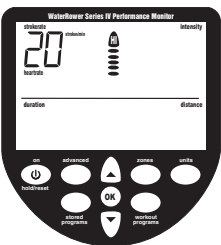

1. Press the **Zones** button *three (3) times*.
2. Using the **Arrows**, scroll to the desired *upper limit*.
3. Press **OK**.
4. Using the **Arrows**, scroll to the desired *lower limit*.
5. Press **OK**; Row.

ADVANCED BUTTON

ADVANCED PROGRAM 1: STORE WORKOUT SETTINGS

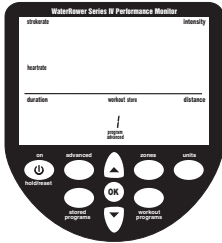

This program allows manual storage of workout settings. This is useful if the S4 monitor is used by numerous users and the AutoStore programs are overwritten.

1. Press the **Advanced** button *one (1) time*.
2. Press **OK**.
3. Using the **Arrows**, scroll to desired workout storage location (1-9).
4. Press **OK**.

ADVANCED PROGRAM 2: RETRIEVE WORKOUT SETTINGS

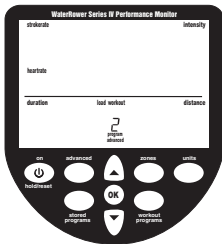

1. Press the **Advanced** button *two (2) times*.
2. Press **OK**.
3. Using the **Arrows**, scroll to desired workout storage location (1-9).
4. Press **OK**.
5. The workout settings stored in the selected location will be loaded.

Retrieving workouts can also be loaded by pressing the **stored programs button (see *Autostore Programs* section).*

ADVANCED PROGRAM 3: PROJECTED DURATION

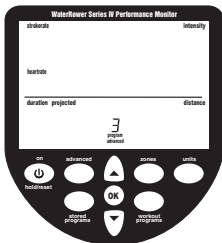

Projected duration is the duration projected for the set distance given the current intensity. Projected duration must be selected immediately prior to the workout and is current only for that workout.

1. Press the **Advanced** button *three (3) times*.
2. Press **OK**; Row.

Projected duration is now selected and will be displayed in lieu of *duration* for 2 seconds out of every 10 seconds.

ADVANCED PROGRAM 4: PROJECTED DISTANCE

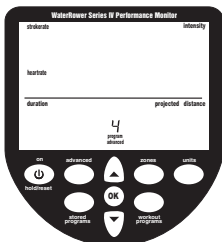

Projected distance is the distance projected for the set duration given the current intensity. Projected distance must be selected immediately prior to the workout and is current only for that workout.

1. Press the **Advanced** button *four (4) times*.
2. Press **OK**; Row.

Projected distance is now selected and will be displayed in lieu of *distance* for 2 seconds out of every 10 seconds.

ADVANCED BUTTON (CONTINUED)

ADVANCED PROGRAM 5: RATIO

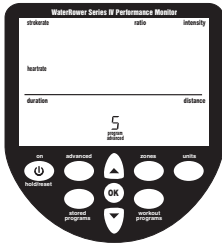

Advanced Program 5 allows you to view the ratio between the power and recovery parts of the stroke. The recovery ratio must be selected immediately prior to the workout and is current only for that workout.

1. Press the **Advanced** button *five (5) times*.
2. Press **OK**; Row.

Power:Recovery Ratio is now selected and will be displayed in lieu of *duration* for 2 seconds out of every 10 seconds.

ADVANCED PROGRAM 6: ADVANCED HEART RATE ANALYSIS

Advanced Program 6 is available only during Heart rate Zone Workouts and must be viewed following the workout.

1. Press the **Advanced** button *six (6) times*.
2. Press **OK**.
3. Heart rate statistics will display the following information:

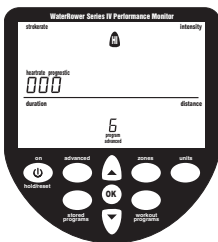

Maximum (peak) heart rate:
The maximum heart rate achieved shows in the heart rate window.

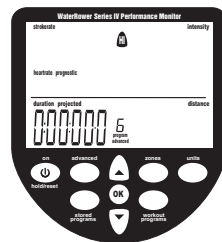

Total time spent above the desired heart rate zone:
The time spent above the heart rate zone hi setting shows in the time window.

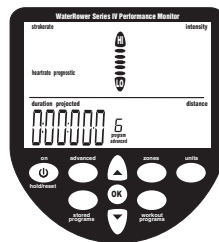

Total time spent within the desired heart rate zone:
The time spent between the heart rate zone hi and lo shows in the time window.

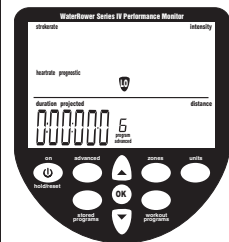

Total time spent below the desired heart rate zone:
The time spent below the heart rate lo setting shows in the time window.

ADVANCED PROGRAM 7: PROGNOSTICS

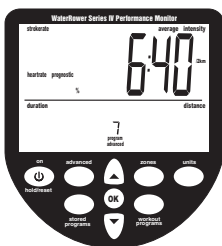

Advanced Program 7 allows you to view your prognostics (the % of a defined 2km time). **This option is available only during 2km workouts.**

1. Press the **Advanced** button *seven (7) times*.
2. Press **OK**.
3. Enter your expected 2km time using the **Arrows**.
4. When desired 2km duration is reached, press **OK**.

ADVANCED BUTTON (CONTINUED)

ADVANCED PROGRAM 8: TANK VOLUME

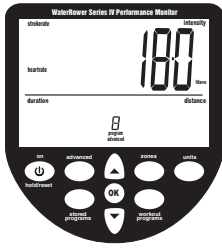

This program allows you to input the volume of water in the tank. The tank volume is necessary in calculation of power (watts).

1. Press the **Advanced** button *eight (8) times*.
2. Press **OK**.
3. Using the **Arrows**, enter the tank volume (seen in the intensity window).
4. When desired volume is reached, press **OK**.

ADVANCED PROGRAM 9: FIRMWARE VERSION / TOTAL MACHINE DISTANCE

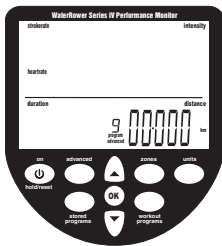

This program allows you to view the Firmware Version (the version of the software that runs the monitor) and the total distance the machine has traveled.

1. Press the **Advanced** button *nine (9) times*.
2. The total lifetime distance (in km) will be displayed.
3. Press **OK**.
4. The total lifetime distance (in km) and Firmware version will be displayed.

STORED PROGRAMS BUTTON

AUTOSTORE PROGRAMS

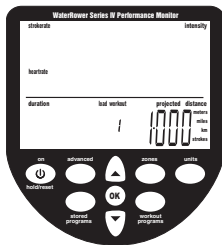

The WaterRower S4 monitor includes an AutoStore function which automatically stores the last 9 historic workout program settings.

Note: Changing the batteries will erase stored programs.

RETRIEVING AUTOSTORE PROGRAMS

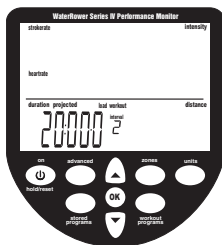

1. Press the **Stored Programs** button.
2. The historic sequence of workouts (1-9) will appear in the program window.
3. The monitor will automatically scroll through the workout settings.
4. When desired workout is highlighted, press **OK**; Row.

LIMITED WARRANTY

What This Limited Warranty Covers: In-Home and Commercial Use - WaterRower (US) Inc. ("WaterRower") will replace or repair at its factory or nominated service facility any WaterRower Rowing Machine ("the Product") found to be defective in material or workmanship for a period of ONE (1) YEAR from the date of initial shipment of the Product by WaterRower. This Limited Warranty is upgradeable to THREE (3) YEARS on all components and FIVE (5) YEARS on the structural frame by registering the Product within the first year of purchase.

WaterRower warrants against any replacement WaterRower spare part received from WaterRower or any of its authorized dealers for a period of NINETY (90) DAYS after the date of shipment.

This Limited Warranty applies to the initial purchasers of the Product or spare part and is not transferable to any other party.

How Can a Customer Obtain Warranty Service: A customer making a warranty claim is responsible to return that defective Product or component to WaterRower's factory or its nominated service center, prepaying all postage or other shipping charges. The Product or component must be returned to your nearest WaterRower office or nominated service center (<https://www.waterrower.com/us/contact-us>). The customer must first notify WaterRower of his/her intent to return the Product or component and receive a confirmation from WaterRower before the Product is returned.

Claimant's Responsibilities: A claimant must ensure that the defective Product or component are properly packed to protect it from damage during shipping. WaterRower will not be responsible for any damage that occurs to the Product or component during shipment.

What WaterRower Will Do: WaterRower, will review, repair or replace the Product or component at WaterRower's discretion. WaterRower will then return the repaired or replaced Product or component to the claimant at WaterRower's expense. WaterRower will ground/economy ship all replacement warranty Products or components to claimant. Charges will apply for any alternative shipping methods requested by claimant. Product shipped outside of its initial purchase country may be subject to additional shipping costs. Where the product warranty has been deemed void, the costs of repair and any associated shipping costs shall be borne by the claimant. WaterRower will contact the claimant prior to return of the repaired Product or component.

This Limited Warranty Will be Void When: This Limited Warranty will be void if the claim has resulted from: (a) improper assembly of the Product, (b) usage of the Product beyond its design, (c) overfilling of the Product's water tank, as explained in the WaterRower Assembly Manual, (d) use of a purification product in the water tank other than that which has been approved by WaterRower, (e) use of improper cleaning materials, as described in the preventative maintenance steps in the WaterRower Owner's Manual, (f) use and/or storage of Product in inclement weather, including but not limited, to extreme temperatures and moisture; (g) accident, abuse, misuse, misapplication or as a result of any modification other than that authorized by WaterRower, and (h) improper preventative maintenance steps as described in the WaterRower Owner's Manual.

Restriction on Other Damages: WaterRower shall not be liable for any direct, consequential, incidental, indirect or special damages under this Limited Warranty or



UNITED STATES | www.waterrower.com
560 Metacom Avenue | Warren, RI 02885
Tel: +1 (401) 247 7742 | info@waterrower.com

UNITED KINGDOM | www.waterrower.co.uk
19 Acton Park Estate | The Vale, London W3 7QE
Tel: +44 (0)20 8749 9090 | info@waterrower.co.uk

AUSTRALIA | www.waterrower.com.au
72 South Street | Rydalmere NSW 2116 Australia
Tel: +61 (0) 2 9898 1405 | info@waterrower.com.au