



M1 ROWER



Owner's Manual
Assembly Instructions
Troubleshooting Guide
Monitor Instructions

TABLE OF CONTENTS

Owner's Manual	02 – 08
Assembling Your Rower	09 – 16
Filling and Emptying the Tank	17 – 21
Troubleshooting	22 – 23
Operating the S4 Monitor	24 – 30
Limited Warranty	31 – 32

PLEASE MAKE NOTE OF YOUR WATERROWER'S SERIAL NUMBER

This number can be found on the back of your rower's monitor. You will need this number when contacting WATERROWER for customer support.





WATERROWER

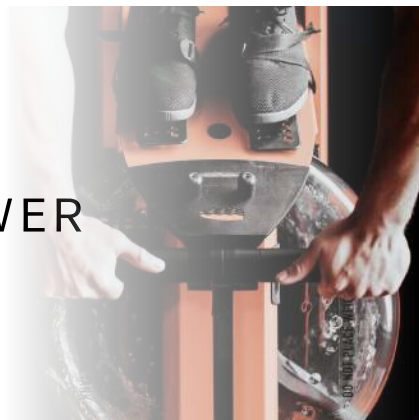

OWNER'S MANUAL

Congratulations on becoming a WaterRower owner! Rowing is universally recognized as the perfect aerobic exercise – smooth, low impact, rhythmic, and whole-body – unrivalled for its physiological benefits and aesthetic pleasures.

While most rowing machines imitate the action of rowing, they do so mechanically, and therefore lack the natural dynamics experienced when a boat and crew glide down a river.

At WATERROWER, we have focused on replicating the physical dynamics of rowing, with the knowledge that this will achieve all of its physiological benefits, as well as much of the aesthetic pleasure.

To maximize the enjoyment from using your WaterRower we recommend that you follow our suggestions on rowing technique and training programs. We hope that some of the discussion points in this manual will improve your knowledge about exercise in general, so that you are better able to reach your fitness goals.

Your WaterRower has been carefully handcrafted to give you years of trouble-free use.

We recommend that you closely follow the assembly details provided, particularly by assembling the machine in the correct sequence and adhering to the suggested maintenance schedule.

We hope you enjoy using your WaterRower for many years to come!

SAFETY

We recommend consulting a physician before starting out with an exercise program. Please read all instructions before using the WaterRower. Additional information on getting started, rowing technique, and rowing training advice can be found at www.HowToRow.com.

CAUTION: Please keep hands away from moving parts when rowing. Failing to do so can lead to injury. For further information on safety tips, please refer to www.waterrowerservice.com/safety-precautions.



"BREAKING IN" YOUR WATERROWER

During the first weeks of use, your WaterRower will adjust to use and the temperature / humidity of the environment. During this period we advise GENTLY tightening all the connecting bolts with the supplied 5mm ratchet. Please be careful not to overtighten any of these bolts.

YOUR WATERROWER'S OPERATING PRINCIPLE

The WaterRower is unique in using the effect of drag to provide an exercise which is entirely self-paced. Because drag is linked to speed, a crew rowing down a river chooses its intensity of exercise simply by altering the pace at which they row. As the boat travels faster, the crew must work harder to overcome the increased drag forces – similar to the way a competitive swimmer must work harder to go faster.

By replicating these dynamics, the WaterRower does not require adjustment to increase resistance. If a more intensive workout is required, simply increase your stroke rate, power per stroke, or both; the WaterRower will respond accordingly.

POSITIONING THE FOOTPADS

The footpads have been engineered to be adjusted for maximum comfort. The footstraps are designed to cross the foot at the pivot point of the toes (the ball of the foot). This should enable the heel to be raised off the footboard as the user comes forward with each stroke.

The footpads can be easily adjusted to accommodate different users – simply lift the top lip of each footpad to unhook it, then slide up or down to reposition on another hole.

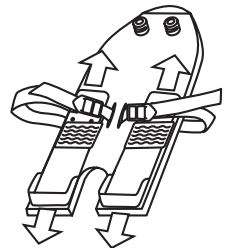

USING YOUR WATERROWER

The Rowing Action uses 84% of your muscle mass. From the tips of your fingers holding the handle/oars to the balls of your feet connected to the footboard/boat, all the muscles between these 2 points contribute to the Rowing Action.

The Rowing Action is comprised of both fast (drive phase) and slow (recovery phase) movements. It is important to combine these 2 movements into a rhythm in order to create a smooth, flowing, unhurried Rowing Action. The following diagrams show 3 basic movements of the Rowing Action.

Allow yourself the first few rowing sessions to practice the correct positions and phases as well as the correct ratio and rhythm of the rowing action. With regular rowing, the technique will become easier and you will soon experience the physiological benefits of rowing.

Please visit www.HowToRow.com to learn more about rowing technique.

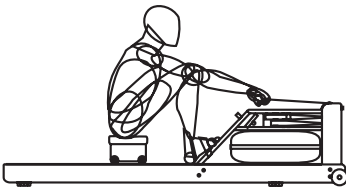

Catch Position

Sitting tall, arms straight reaching forward, shoulders relaxed, head up, eyes looking forward, legs compressed, and shins vertical.

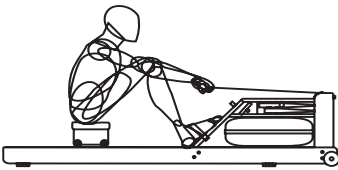

Drive Phase

Drive backward with the legs, arms hang off the handle and only begin to bend once handle is above the knees, torso is strong with good posture and body angle opens up slowly as you drive the legs.

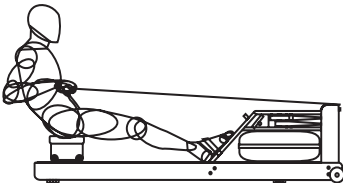

Release Position

Legs straight, handle drawn to chest, sitting back just past the vertical, torso firm, shoulders relaxed, head up, and eyes looking forward.

STORING YOUR WATERROWER

To store your WaterRower upright, slide the seat forward towards the footboard prior to lifting the rower. Then, lift the rear spacer, pull the WaterRower towards you, and use the momentum to stand it in an upright position. When stored upright, the WaterRower is stable and only takes up the space of a chair.

CREATING YOUR EXERCISE PROGRAM

Do you want to reduce or maintain your weight? Perhaps you'd like to improve your physique. Are you a competitor that wants to train harder? Maybe you simply want to avoid the negative effects of a modern sedentary lifestyle. Whatever the case may be, identifying your fitness goal is essential to creating your exercise program – but it is equally important to understand *how* to achieve that goal by creating a roadmap to get there.

One of the best ways to do this is identifying short- and long-term objectives (stepping stones on the path to your fitness goal) that are **SMART**:

- **Specific** – a goal that is specific and has a targeted expectation
- **Measurable** – a goal that is trackable, so you can both measure your progress and hold yourself accountable
- **Attainable** – a goal that is both achievable and realistic will set you up for success and ensure you stay motivated
- **Relevant** – a goal that aligns with your fitness objective and makes sense to incorporate into your fitness plan
- **Time-Bound** – a goal with a time-sensitive element means you will be able to plan the incremental changes you need to achieve the goal and set milestones along the way

Here are some examples of SMART objectives:

- Short-term: *By fall, I will become an active member of a rowing club.*
- Long-term: *By this time next year, I will be a competitive rower and enter my first rowing regatta.*

Keeping yourself on track to achieve your goal(s) is essential. Consider holding yourself accountable by:

- blocking out time on your calendar for workouts
- joining exercise classes where regular attendance is expected
- consulting with a personal trainer or coach to map out a plan for you
- keeping a journal of your progress and celebrating when you accomplish your goals

HOWTOROW WEBSITE

HowToRow is WATERROWER's rowing education website for users of all experience levels. Get the most out of your WaterRower as you learn how to improve technique, develop a workout plan, track performance progress, and more! For more information, please visit www.HowToRow.com.

WATERCOACH PROFESSIONAL PROGRAM

WaterCoach Professional is an ACE-certified course designed for fitness professionals and instructors to improve instruction on rowing, training, physiology, and technique for clients. For more information, please visit www.HowToRow.com/watercoach-professional.

WEIGHT MAINTENANCE

At lower intensities, our body uses a mixture of fat and carbohydrates as its source of fuel. As the maximum aerobic output is approached, the percentage of fat consumed as fuel reduces to zero. Also, as the duration of exercise is increased, the percentage of fat consumed tends to increase.

If your objective is weight maintenance, then the energy (food) you consume must equal energy used (exercise and metabolism). Exercising for weight maintenance is best achieved at lower intensities and over longer durations. A low exercise intensity (60 - 70% of the maximum heart rate) is about that achieved by a brisk walk – it is by no means strenuous; you should be able to hold a conversation.

AEROBIC TRAINING

A sustained exercise program will improve the efficiency with which the respiratory and cardiovascular system can supply oxygen. This improves lung function, heart function, vascular efficiency, and capillary growth, leading to improved well-being and endurance. At about 70 - 80% of the maximum heart rate, lactic acid begins to accumulate in the blood supply at a greater rate than it can be extracted by the liver, kidneys, and other organs. Exercising above this intensity will cause progressive accumulation of lactic acid in the blood and increased heart and breathing rates – causing muscle fatigue.

Prolonged exercise at or below this intensity will maintain lactic acid at non-fatiguing levels and exercise duration will be limited solely to the depletion of available fuel stores. If your exercise objective is aerobic training (cardiovascular/endurance), then it is necessary to exercise at an intensity which will avoid fatigue due to lactic acid buildup. This is best achieved at moderate levels of intensity over medium/long durations.

A moderate exercise intensity (70-80% of the maximum heart rate) is about that achieved by a steady jog, avoiding the onset of muscle soreness.

ANAEROBIC TRAINING

Anaerobic training causes the buildup of lactic acid (as rapidly as one minute after exercise is commenced). Lactic acid saturation will necessitate either a rapid reduction in exercise intensity or complete cessation.

The accumulation of lactic acid limits the contribution of the anaerobic process to total energy production. Though energy may be generated rapidly, total work capacity and total output is limited.

The level of intensity at which lactic acid begins to accumulate can be altered by training. This is best done by improving the efficiency of the aerobic process and is achieved by training at moderate levels of intensity.

Exercising at anaerobic intensities may condition an athlete's tolerance to fatigue, but the benefit can be more psychological than physiological. Prolonged exercise at high intensity not only impairs the weight reduction and aerobic training effect, but also brings rapid onset of fatigue, can cause poor technique, and increase risk of injury.

Training anaerobically is done at high intensities (80-100% of the maximum heart rate) over a short period of time (10 seconds to a few minutes). Interval training is a form of anaerobic training.

TRAINING RECOMMENDATIONS

To ensure that you get the maximum benefit from training on your WaterRower and avoid unnecessary problems or injuries, we recommend:

- Consulting your doctor before starting an exercise program
- Using a heart rate to measure and monitor your intensity
- Always warming up and cooling down
- Always stretching, especially at the end of your workout
- Keeping a record of your workouts
- Staying well-hydrated
- Gradually increasing the intensity, duration, and / or frequency of your workouts over time
- Including recovery time in your training program
- Adding variety to your workouts

PREVENTATIVE MAINTENANCE

Periodic maintenance is required to maintain the condition of the water in the tank. We advise using municipal tap water, as it contains treatments to keep it free from bacteria and algae, etc. Alternatively, you may also use distilled water. **DO NOT** use well water.

The water must be refreshed periodically by adding a Water Purification Tablet (provided). The purification tablet degrades by exposure to light: this may vary from 3 months in direct sunlight to 2 years in an artificially lit environment. Generally we suggest adding one purification tablet every 3-6 months. Additional purification tablets are available upon request at www.waterrowerservice.com/puritabs.

If water discoloration occurs before 3 months have passed, add a purification tablet immediately. If the water does not clear, we recommend emptying the tank, flushing it out with clean water, refilling, and adding a purification tablet. **NEVER USE POOL CHLORINE OR CHLORINE BLEACH** in the tank as this will irreparably damage the polycarbonate tank. The use of any water purification method other than purification tablets supplied by WATERROWER could void the warranty.

Note: If using blue dye in your tank, remove and replace the water in the tank every 6-12 months. Do NOT use purification tablets as they will only "cancel out" the blue dye resulting in clear water that has not been purified.

CLEANING YOUR WATERROWER

To maintain the appearance and integrity of your WaterRower, it is necessary to keep the machine clean. It is particularly important to ensure that there is no dust buildup in the clutch and belt mechanism between the top and bottom decks. Dust can be removed by using a cloth, vacuum cleaner, or compressed air.

The surface of the rails must be kept clean to prevent dust and dirt from damaging the seat load wheels. Clean the rails by wiping with a damp cloth.

We recommend cleaning the surface of the tank with either a solution of soap and water or 70% isopropyl alcohol. **DO NOT** use chemical cleaners of any kind on the tank as it may damage the polycarbonate tank material.

DO NOT USE METHYLATED SPIRITS, AMMONIA-BASED FLUIDS, CHLORATES, OR BLEACH WHEN CLEANING ANY PART OF YOUR WATERROWER. The use of improper cleaning products could void the warranty.

MAINTAINING THE METAL FRAME

The metal surfaces of your WaterRower's frame can be wiped clean with a damp cloth. A small amount of nonabrasive cleaner may be used, if desired. Using and / or storing your WaterRower in inclement weather, including (but not limited to) extreme temperatures and moisture, could void the warranty. Please only store your WaterRower indoors.

ASSEMBLING YOUR ROWER

OVERVIEW

Assembling your WaterRower takes about 30-45 minutes. Tools needed are included, however a flat-blade screwdriver is also recommended. Your WaterRower comes partially assembled.

Please read the instructions in this manual fully before assembly. We also recommend viewing the assembly video located at www.waterrowerservice.com/assembly-videos.

MAIN PARTS

- A. Rail Set (*pair - left / right*)
- B. Rear End Pad Assembly (*with bungee*)
- C. Seat Assembly
- D. Footboard Assembly
- E. Tank Assembly
- F. Top Cover

ANCILLARY PARTS

- G. 10 x Button Head Cap Screw (*WRP-B505; 2 in bits tray, 8 installed on end pads*)
- H. 10 x Washer (*WRP-B500 2 in bits tray, 8 installed on end pads*)
- I. 2 x Handle Rest (*WRP-P430*)
- J. 2 x Handle Rest Bolt (*WRP-P455*)
- K. 1 x 5mm Ratchet (*WRP-B475*)
- L. 2 x Footpad (*WRP-B700*)
- M. 1 x Syphon Pump (*WRP-B405*)
- N. 2 x Purification Tablet (*WRP-B960*)
- O. 1 x Water Blue Solution (*630*)

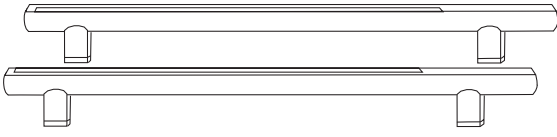

A



B



C

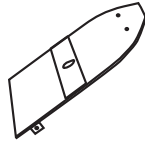

D

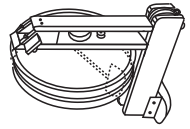

E

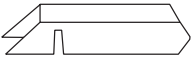

F



G



H



I

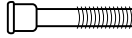

J



K

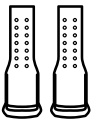

L



M

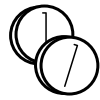

N



O

ASSEMBLY PROCESS

STEP 1

Remove the rails (A) from their box(es), noting the label on the boxes specifying the **left** and **right** rails. Stand the rails on their feet with the *WaterRower* decals facing outward. Remove the rear end pad assembly (B) from the tank box. Carefully align the brackets of the rear end pad assembly with the interior (tubular) section of the rails, ensuring that the *WaterRower* logo is oriented so it is legible.

Note: The rear end pad should be installed on the end of each rail that is closest to the black plastic extrusions the seat rolls upon.

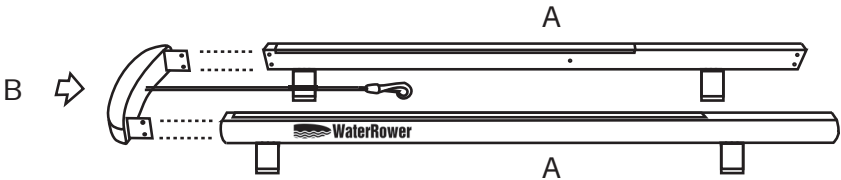

STEP 2

Using the provided ratchet (K), secure the rear end pad assembly to the rails using 4 button head cap screws (G) and 4 washers (H).

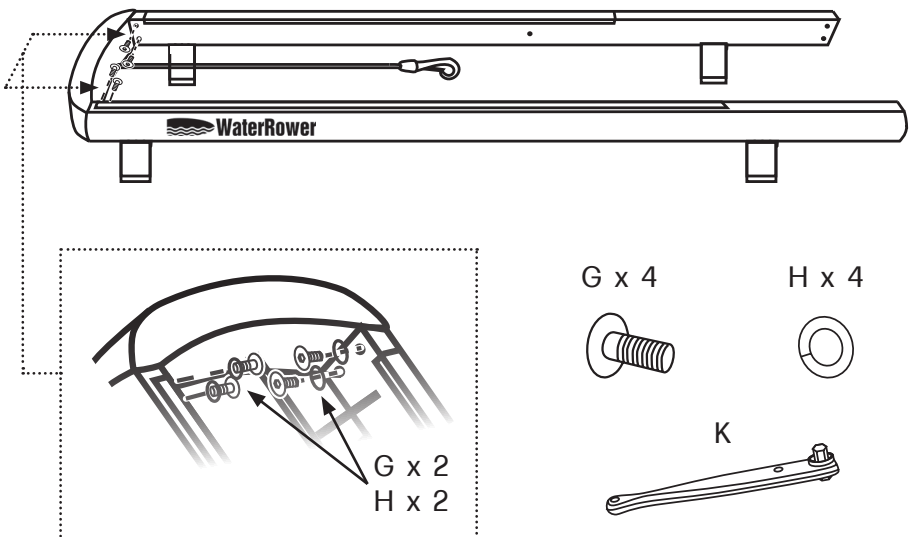

STEP 3

Remove the seat assembly (C) from the tank box and place it on / between the rails. The indented portion of the seat cushion must face towards the rear spacer as shown. The larger, vertical wheels (load wheels) should sit on the plastic extrusions on top of each rail. The smaller, horizontal wheels below the seat (guide wheels) should sit between the rails, underneath the lips of the black plastic extrusions. Once the seat is installed, slide it to the back of the rails.

Note: It may be necessary to spread the rails slightly to allow the guide wheels to fit between the rails and under the lips of the extrusions.

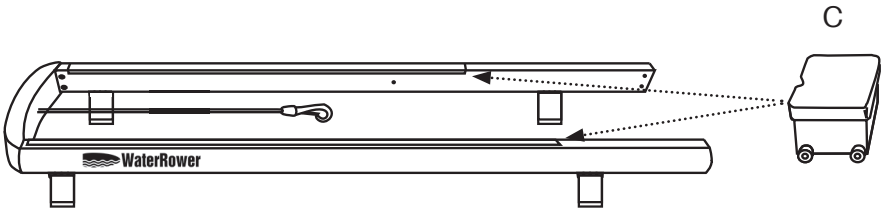

STEP 4

Remove the footboard (D) from the tank box. With the black plastic components and WaterRower logo facing upward, carefully slide the footboard between the rails.

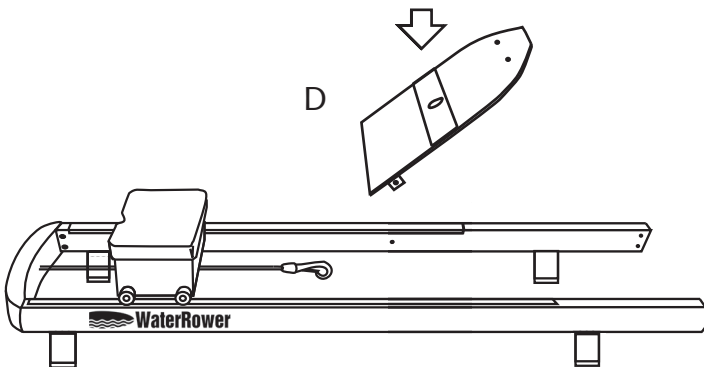

STEP 5

Using the provided ratchet (K), secure the footboard to the rails using 2 button head cap screws (G) and 2 washers (H).

Note: There is a spacer attached to both sides of the footboard. The spacers must be positioned between the rails and footboard on both sides for proper assembly.

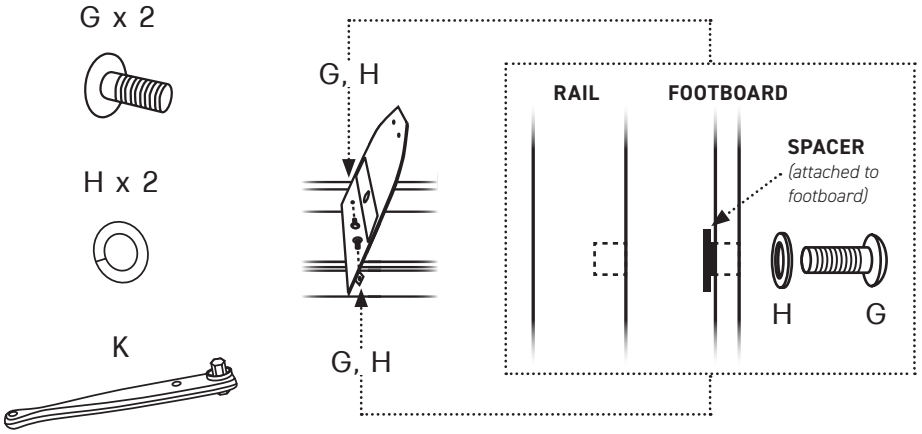

STEP 6

Remove the tank assembly (E) from the tank box. Carefully place the tank assembly between the rails.

Note: The metal brackets protruding from the front end pad (on tank assembly) fit inside the tubular section of the rails in the same way that the rear end pad assembly fit into the rails.

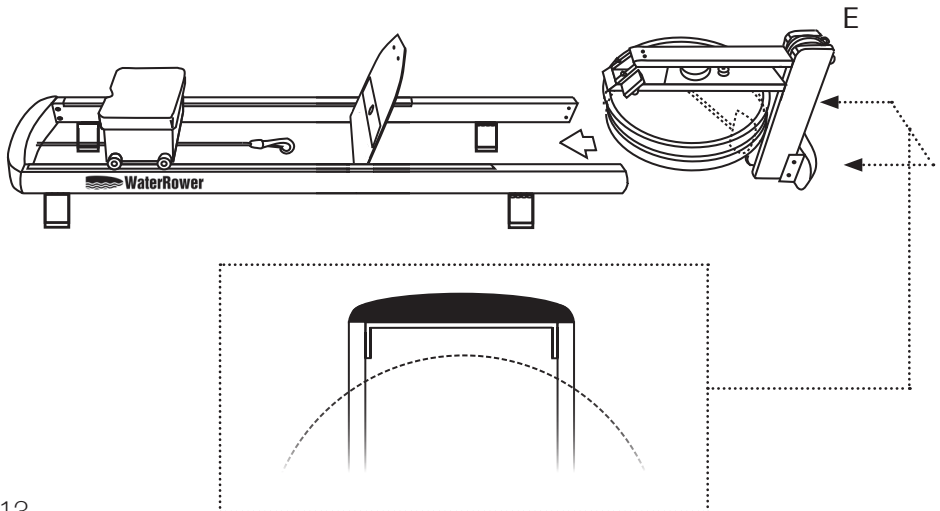

STEP 7

Using the provided ratchet (K), secure the front end pad of the tank assembly to the rails using 4 button head cap screws (G) and 4 washers (H).

Note: The metal brackets protruding from the front end pad (on tank assembly) fit inside the tubular section of the rails in the same way that the rear end pad assembly fit into the rails.

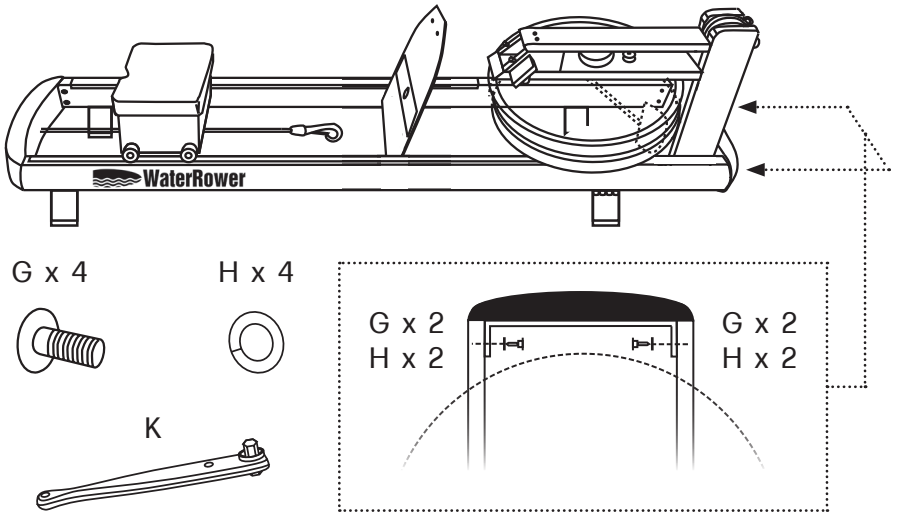

Pro Tip: Depending on your preference, you may choose to fill the tank with water at this point. See pages 17-19 for methodology.

STEP 8

Remove the top cover (F) from the tank box. Starting just behind the monitor, position the cover at an angle. Slide the cover simultaneously **downward** and **horizontally forward** (towards the front of the rower) so that it covers the clutch mechanism area. Gently fit the front edge of the cover into the supporting / protective shims, if equipped.

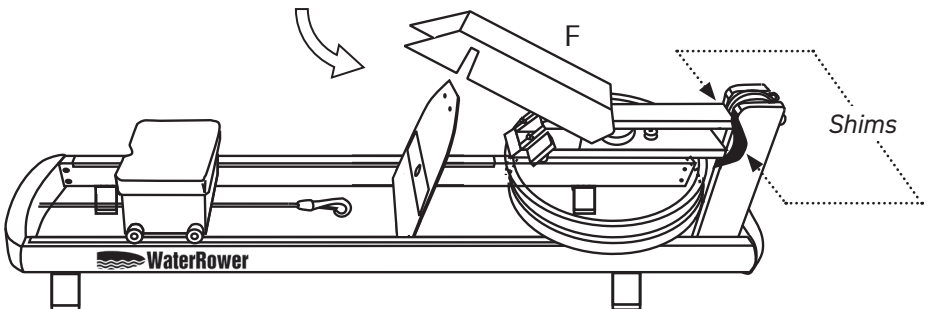

STEP 9

Gently rotate the footboard forward until it rests against the slanted brackets of the tank assembly. The holes in the top of the footboard (for the handle rests) should align with the threaded inserts of the slanted brackets.

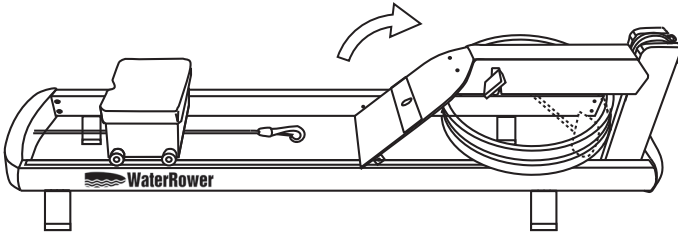

STEP 10

Using the provided ratchet (K) and 2 handle rest bolts (J), install both handle rests (I). Ensure that the flat surface of the handle rests is parallel to the ground.

Note: This step also secures the footboard to the black slanted brackets of the tank assembly. When installing the handle rest bolts, take care not to overtighten them or install them using a power tool – permanent damage to the brackets may result.

I x 2



J x 2

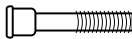

K



I, J

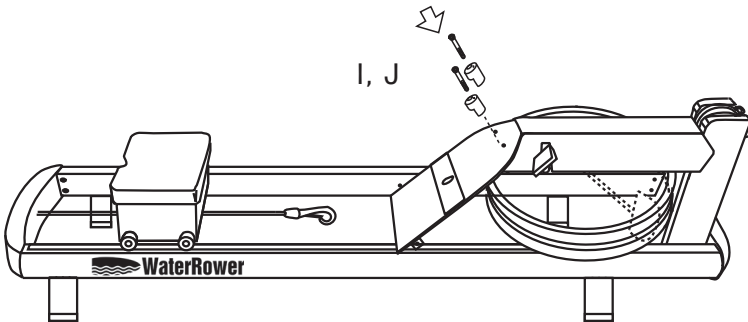

STEP 11

Remove both footpads (L) from the tank box. With the heel cups facing upward, slide each footpad through the cavity of its cover plate.

Use a flat-head screwdriver to lift the footpad up and over the adjustment pins.

If footpad position adjustment is required, simply lift the top lip of the footpad up to unhook it and reposition to another hole.

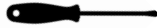

FLAT-HEAD SCREWDRIVER

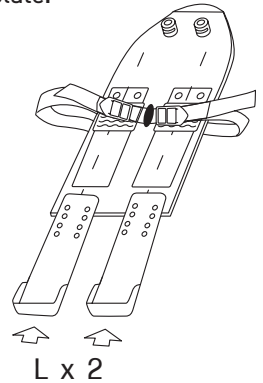

STEP 12

Stand the rower upright, ensuring the bungee and recoil belt are accessible. Unravel the recoil belt from the bottom bracket of the tank assembly. Feed the recoil belt over both guide pulleys in the forward riser.

Connect the bungee to the recoil belt by linking the bungee's hook with the recoil belt's D-ring.

Ensure the handle strap and recoil belt are aligned on the forward riser drive and guide pulleys.

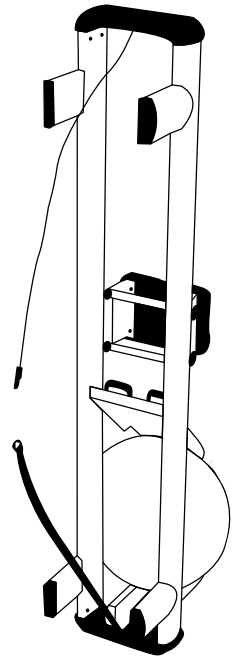
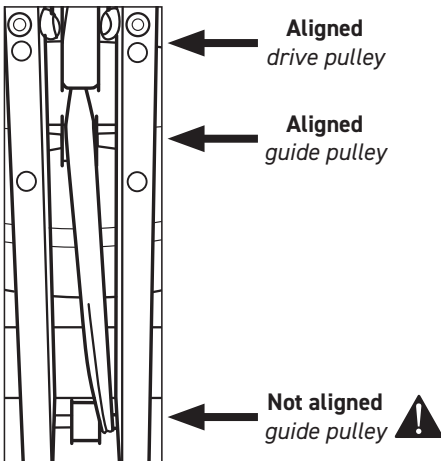

FILLING AND EMPTYING THE TANK

WATER LEVEL

The Water Level Gauge is positioned on the side of the tank. We advise filling the tank to the standard calibration level – **Level 17**.

The maximum fill point for the tank is Level 19. **DO NOT** fill above the maximum level – this could void the warranty.

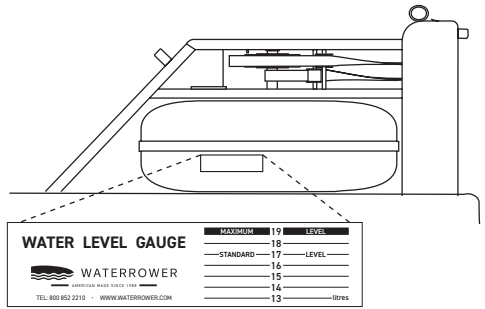

FILLING THE TANK

STEP 1

Remove the rubber access door from the top cover.

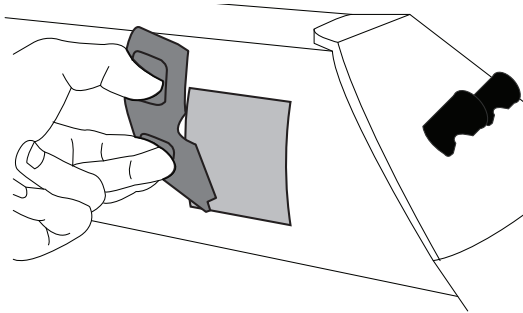

STEP 2

Remove the tank stopper.

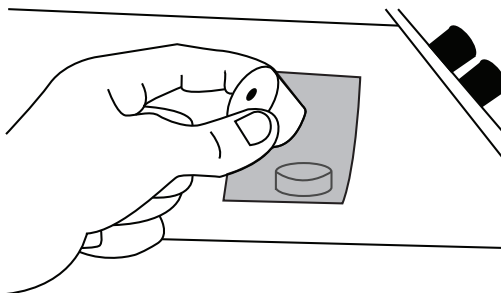

STEP 3

Locate the syphon pump (M) in the tank box. Turn the valve of the pump **clockwise** to close the syphon's valve.

Note: You may use a hose to fill the tank instead of the syphon pump, if you prefer.

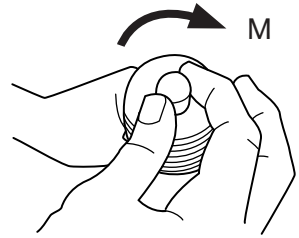

STEP 4

Place a bucket of municipal tap or distilled water at a height that is **higher than the tank assembly, such as on a chair**. Insert the syphon's take-up tube into the bucket of water and the syphon's hose into the tank of the rower.

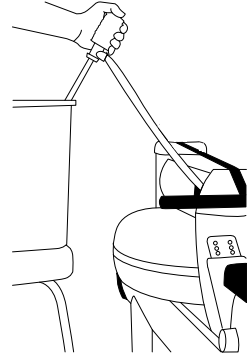

STEP 5

Squeeze the pump 4-5 times, until water begins flowing from the bucket into the tank.

Note: Do NOT overfill the tank. Anything beyond Level 19 (the maximum level indicated on the tank water level gauge) may risk leaking and void your warranty.

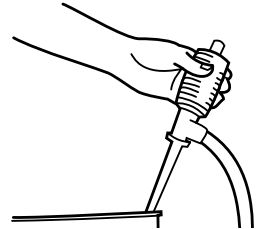

STEP 6

To stop the flow of water, turn the valve of the pump **counter-clockwise** to open the syphon's valve.

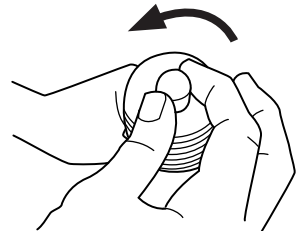

STEP 7

Insert 1 purification tablet (N) into the tank. Then, reinstall the tank stopper.

Note: It may be necessary to moisten the tank stopper to assist with installation.

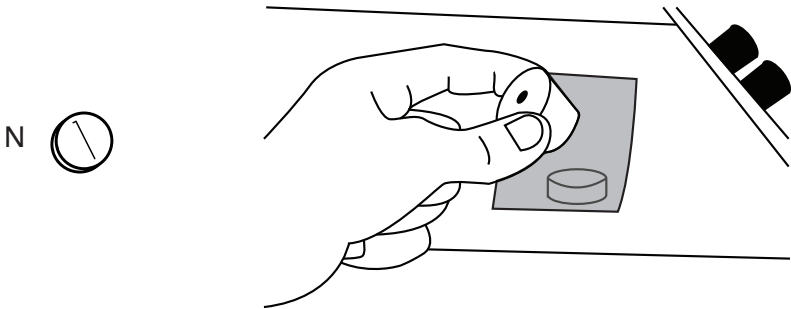

STEP 8

Reinstall the rubber access door from the top cover.

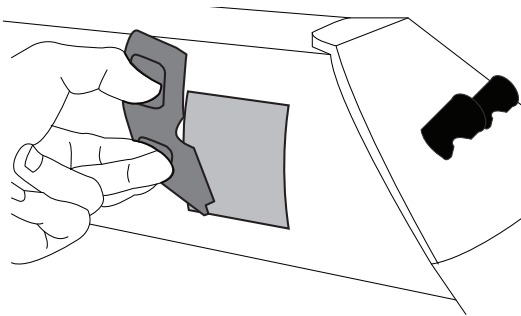

EMPTYING THE TANK

STEP 1

Remove the rubber access door from the top cover.

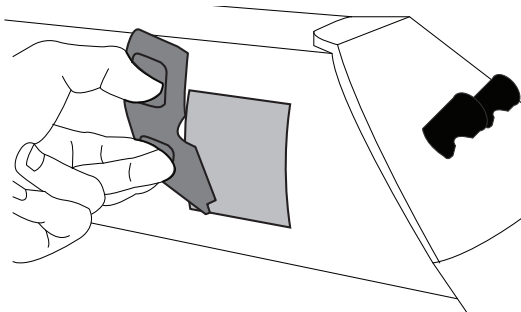

STEP 2

Remove the tank stopper.

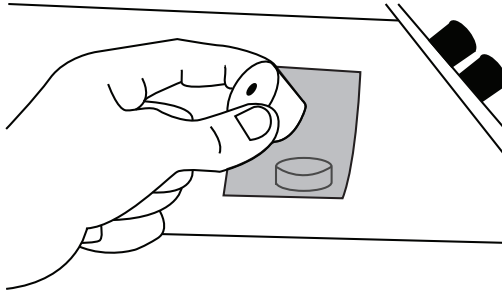

STEP 3

Turn the valve of the pump *clockwise* to close the syphon's valve.

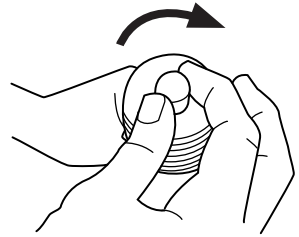

STEP 4

Place a bucket *on the floor*. Insert the syphon's take-up tube into the tank of the rower and the syphon's hose into the bucket.

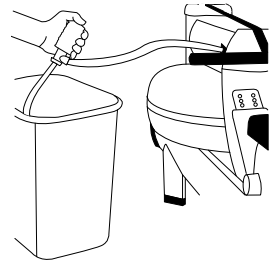

STEP 5

Squeeze the pump 4-5 times, until water begins flowing from the tank into the bucket.

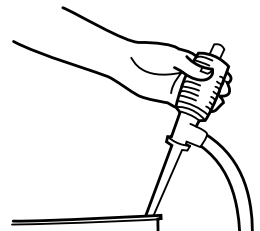

STEP 6

To stop the flow of water, turn the valve of the pump *counter-clockwise* to open the syphon's valve.

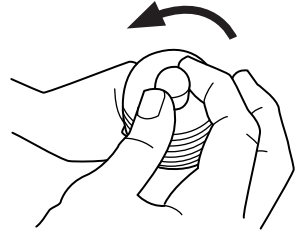

STEP 7

Reinstall the tank stopper.

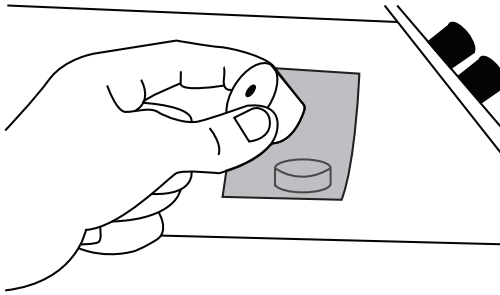

STEP 8

Reinstall the rubber access door from the top cover.

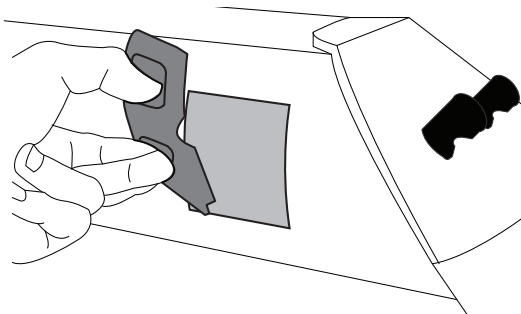

TROUBLESHOOTING

RECOIL BELT REQUIRES ADJUSTMENT

Make sure the recoil belt is properly tensioned:

- The recoil belt is too tight if the bungee is resisting you at the back of your stroke (when you are farthest from the tank)
- The recoil belt is too loose if there is slack during the recovery phase of your stroke (when you are coming forward toward the tank)

Adjusting the recoil belt is simple:

1. Rest the handle fully forward (resting against the forward riser).
2. Unclip the recoil belt from the bungee cord.
3. Adjust the recoil belt using the ladder lock buckle of the belt.
4. To increase tension, shorten the belt. To reduce tension, lengthen the belt.

It may be necessary to perform these two simple procedures once or twice over the first month of use. Please refer to *Adjusting the Recoil* video at www.waterrowerservice.com/videos.

MONITOR IS FLASHING ZEROS

SOLUTION 1

Try raising the sensor disk (located on top of the clutch). During shipment, the disk may have shifted.

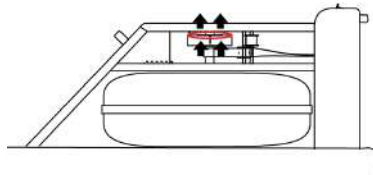

SOLUTION 2

Loosen and retighten the bolts on the top deck and forward riser (locations A and B below). If these bolts are not uniformly tightened during assembly, the alignment may be off.

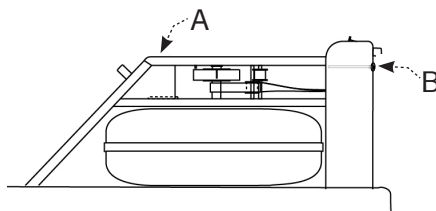

MONITOR DOES NOT COUNT DOWN

Verify the monitor and sensor connector is connected. Check that all wiring is intact.

PADDLE DOES NOT TURN SMOOTHLY

Loosen all tank bolts and retighten. See instructions at www.waterrowerservice.com/m1-guide/#trouble-paddle-m1.

FASTENERS HAVE LOOSENED

Over time and with use, hardware can come loose. Use the provided 5mm ratchet (K) to gently tighten any bolts, JCNs, or JCBs as needed. If the hardware continues to loosen, use a small amount of medium strength Loctite® to fasten these items more securely.

View our complete library of
troubleshooting and service tips at
www.waterrowerservice.com/m1-guide.

If you need additional assistance, contact us at
support@waterrower.com.

OPERATING THE S4 MONITOR

The WaterRower S4 Performance Monitor has been designed to balance a high level of technical sophistication and user-friendliness.

The Monitor consists of the following information buttons and windows – please see the following pages for specific details about each button and window.

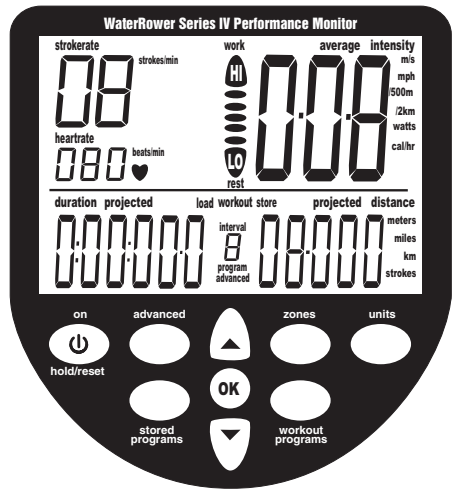

BUTTONS

- **On / Hold / Reset Button**

Press the ON button to start up the monitor: the units will flash ready to count down as you begin rowing. To reset the monitor, press the ON button for 2 seconds.

- **Programming Buttons**

Zones, Workout Programs, Advanced, Stored Programs

- **Navigation / Select / Display Information Buttons**

Up, Down, OK, Units

WINDOWS

- **Information / Programming Windows**

Strokerate, Heart Rate, Duration, Intensity, Average Intensity, Distance

These Information and Programming Windows show your current and programmed workout details.

- **Zone Bar Window**

Seen in the top middle part of the screen, the Zone Hi / Zone Lo bars are used during zone, interval and advanced workouts. They will flash and emit a high frequency tone when your Hi or Lo limit is breached.

- **Stored Workout / Interval Number / Advanced Program Number**

Seen in the bottom middle part of the screen, this window displays numbers to navigate through numbered or sequenced information (stored workouts, intervals and advanced programs).

PRIMARY INFORMATION DISPLAYED ON THE MONITOR

The Monitor can display 6 main types of data when in use:

- A. Strokerate
- B. Heart Rate
- C. Duration
- D. Intensity
- E. Average Intensity
- F. Distance

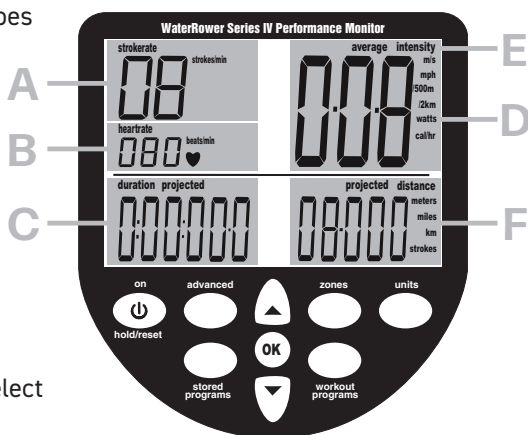

The chart below describes each of these in detail, including how to select desired units.

A – Strokerate	
Displays the number of strokes rowed per minute.	
B – Heart Rate	
Displays current heart rate (requires optional heart rate receiver and transmitter).	
C – Duration	
Displays time in: HOURS, MINUTES, SECONDS, DECIMAL SECONDS.	
D – Intensity	
Displays <u>SPEED / POWER / ENERGY</u> : <ul style="list-style-type: none"> • M/s – METERS PER SECOND • MPH – MILES PER HOUR • /500M – MINUTES PER 500 METERS • /2KM – MINUTES PER 2 KILOMETERS • WATTS – WATTS • CAL/HR – CALORIES BURNT PER HOUR 	To select desired intensity unit: <ol style="list-style-type: none"> 1. Press the Units button <i>once</i>. 2. Use the Arrow buttons to scroll to the desired intensity unit. 3. Press the OK button to select.
E – Average Intensity	
Displays <u>AVERAGE SPEED</u> : <ul style="list-style-type: none"> • M/s – METERS PER SECOND • MPH – MILES PER HOUR • /500M – MINUTES PER 500 METERS • /2KM – MINUTES PER 2 KILOMETERS 	To select desired average intensity unit: <ol style="list-style-type: none"> 1. Press the Units button <i>two (2) times</i>. 2. Use the Arrow buttons to scroll to the desired intensity unit. 3. Press OK to select.
F – Distance	
Displays <u>SPEED / POWER / ENERGY</u> : <ul style="list-style-type: none"> • METERS • MILES • KILOMETERS (KM) • STROKES • CALORIES (KCAL) 	To select desired distance unit: <ol style="list-style-type: none"> 1. Press UNITS <i>three (3) times</i>. 2. Use the Arrow buttons to scroll to the desired distance unit. 3. Press the OK button to select.

WORKOUT PROGRAMS BUTTON

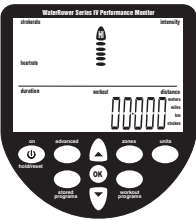
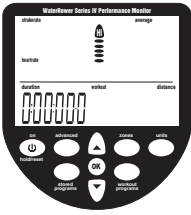
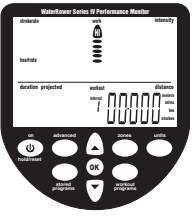
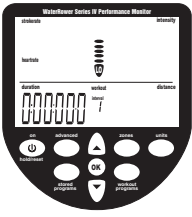
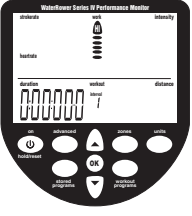
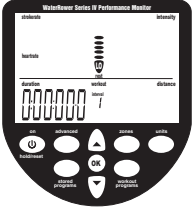
Distance Workout		
	<ol style="list-style-type: none"> 1. Press the Workout Programs button <i>once</i>. 2. Using the Arrow buttons, scroll to the desired workout <i>distance</i>. 3. Press the OK button. Row. 	
Duration Workout		
	<ol style="list-style-type: none"> 1. Press the Workout Programs button <i>two (2) times</i>. 2. Using the Arrow buttons, scroll to the desired workout <i>duration</i>. 3. Press the OK button. Row. 	
Interval Workout – Distance		
		<ol style="list-style-type: none"> 1. Press the Workout Programs button <i>three (3) times</i>. 2. Using the Arrow buttons, scroll to the desired <i>interval one (1) distance</i>. 3. Press the OK button. 4. Using the Arrow buttons, scroll to the desired <i>interval one (1) recovery duration*</i>. 5. Press the OK button. 6. Repeat steps 2-5 (up to 9 distance intervals may be entered). 7. Press the OK button <i>two (2) times</i> to end sequence. Row.
<p>Interval 1 Workout Distance</p>	<p>Interval 1 Recovery Duration*</p>	
Interval Workout – Duration		
		<ol style="list-style-type: none"> 1. Press the Workout Programs button <i>four (4) times</i>. 2. Using the Arrow buttons, scroll to the desired <i>interval one (1) workout duration</i>. 3. Press the OK button. 4. Using the Arrow buttons, scroll to the desired <i>interval one (1) recovery duration*</i>. 5. Press the OK button. 6. Repeat steps 2-5 (up to 9 distance intervals may be entered). 7. Press the OK button <i>two (2) times</i> to end sequence. Row.
<p>Interval 1 Workout Duration</p>	<p>Interval 1 Recovery Duration*</p>	

* **RECOVERY DURATION** OF LESS THAN 2 MINUTES MUST BE SET OR MONITOR WILL POWER OFF.

ZONES BUTTON

Zone setting allows the user to set upper (hi) and lower (lo) limits for *heart rate*, *intensity*, and *strokerate*.

- When the set **zone lo** limit is breached the **zone bar lo** flag will flash and a low frequency tone will emit.
- When the set **zone hi** limit is breached the **zone bar hi** flag will flash and a low frequency tone will emit.
- When operating between the upper and lower zone limits, the position in this range will be displayed by the divisional zone bars.

Heart Rate Zone Setting

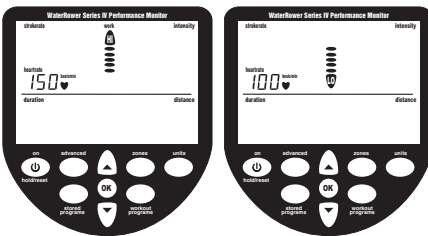

1. Press the **Zones** button *once*.
2. Using the **Arrow** buttons, scroll to the desired **upper limit**.
3. Press the **OK** button.
4. Using the **Arrow** buttons, scroll to the desired **lower limit**.
5. Press the **OK** button. Row.

Intensity Zone Setting

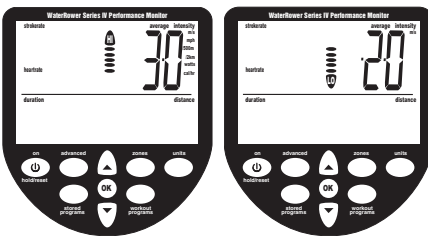

1. Press the **Zones** button *two (2) times*.
2. Using the **Arrow** buttons, scroll to the desired **upper limit**.
3. Press the **OK** button.
4. Using the **Arrow** buttons, scroll to the desired **lower limit**.
5. Press the **OK** button. Row.

Strokerate Zone Setting

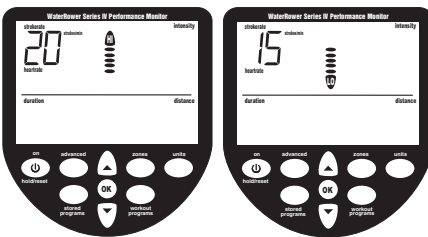

1. Press the **Zones** button *three (3) times*.
2. Using the **Arrow** buttons, scroll to the desired **upper limit**.
3. Press the **OK** button.
4. Using the **Arrow** buttons, scroll to the desired **lower limit**.
5. Press the **OK** button. Row.

ADVANCED BUTTON

Advance Program 1: Store Workout Settings

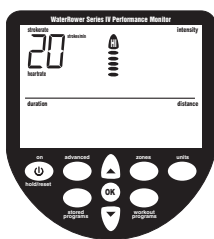

This program allows manual storage of workout settings. This is useful if the monitor is used by several users and the AutoStore programs are overwritten.

1. Press the **Advanced** button *once*.
2. Press the **OK** button.
3. Using the **Arrow** buttons, scroll to the desired workout storage location (1-9).
4. Press the **OK** button.

Advance Program 2: Retrieve Workout Settings

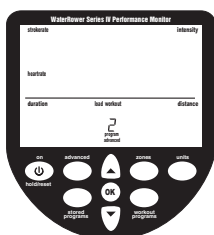

1. Press the **Advanced** button *two (2) times*.
2. Press the **OK** button.
3. Using the **Arrow** buttons, scroll to the desired workout storage location (1-9).
4. Press the **OK** button.
5. The workout settings stored in the selected location will be loaded.

*Note: Retrieving workouts can also be loaded by pressing the **Stored Programs** button (see AutoStore Programs section).*

Advance Program 3: Projected Duration

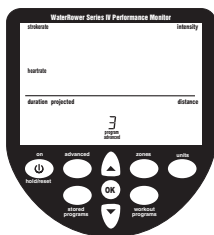

Projected duration is the duration projected for the set distance given the current intensity. **Projected duration** must be selected immediately prior to the workout and is current only for that workout.

1. Press the **Advanced** button *three (3) times*.
2. Press the **OK** button. Row

Projected duration is now selected and will be displayed in lieu of **duration** for 2 seconds out of every 10 seconds.

Advance Program 4: Projected Distance

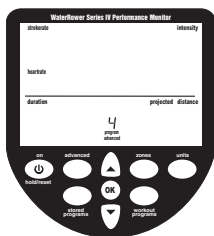

Projected distance is the duration projected for the set duration given the current intensity. **Projected distance** must be selected immediately prior to the workout and is current only for that workout.

1. Press the **Advanced** button *four (4) times*.
2. Press the **OK** button. Row

Projected distance is now selected and will be displayed in lieu of **distance** for 2 seconds out of every 10 seconds.

ADVANCED BUTTON (CONTINUED)

Advance Program 5: *Ratio*

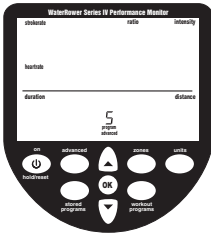

Advanced Program 5 allows you to view the ratio between the power and recovery parts of the stroke. The recovery ratio must be selected immediately prior to the workout and is current only for that workout.

1. Press the **Advanced** button **five (5) times**.
2. Press the **OK** button.

Power:Recovery Ratio is now selected and will be displayed in lieu of **duration** for 2 seconds out of every 10 seconds.

Advance Program 6: *Advanced Heart Rate Analysis*

Advanced Program 6 is available only during Heart rate Zone Workouts and must be viewed following the workout.

1. Press the **Advanced** button **six (6) times**.
2. Press the **OK** button.
3. Heart rate statistics will display the following information:

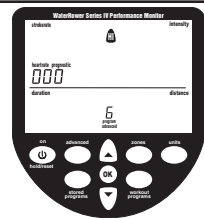

Maximum (peak) heart rate:
The maximum heart rate achieved shows in the heart rate window.

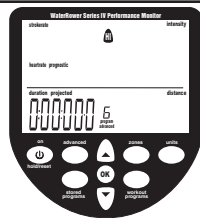

Total time spent above the desired heart rate zone:
The time spent above the heart rate zone hi setting shows in the time window.

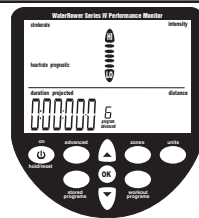

Total time spent within the desired heart rate zone:
The time spent between the heart rate zone hi and lo shows in the time window.

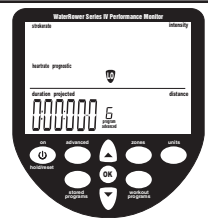

Total time spent below the desired heart rate zone:
The time spent below the heart rate lo setting shows in the time window.

Advance Program 7: *Prognostics*

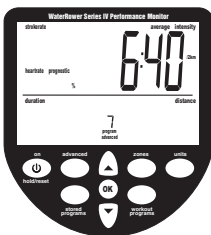

Advanced Program 7 allows you to view the ratio between the power and recovery parts of the stroke. The recovery ratio must be selected immediately prior to the workout and is current only for that workout.

1. Press the **Advanced** button **seven (7) times**.
2. Press the **OK** button.
3. Enter your expected 2km time using the **Arrow** buttons.
4. When your desired 2km duration is reached, press the **OK** button.

ADVANCED BUTTON (CONTINUED)

Advance Program 8: Tank Volume

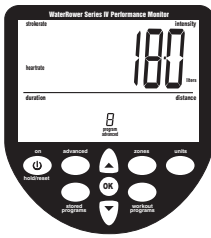

This program allows you to input the volume of water in the tank. The tank volume is necessary in calculation of power (watts).

1. Press the **Advanced** button *eight (8) times*.
2. Press the **OK** button.
3. Using the **Arrow** buttons, enter the tank volume (seen in the intensity window).
4. When the desired volume is reached, press the **OK** button.

Advance Program 9: Firmware Version / Total Machine Distance

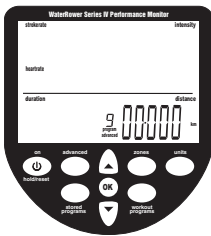

This program allows you to view the Firmware Version (the version of the software that runs the Monitor), as well as the total distance your WaterRower has "traveled".

1. Press the **Advanced** button *nine (9) times*
2. The total lifetime distance (in km) will be displayed.
3. Press the **OK** button.
4. The Firmware version will be displayed.

STORED PROGRAMS BUTTON

AutoStore Programs

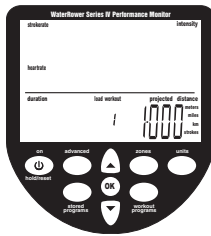

The Monitor includes an AutoStore function which automatically stores the last 9 historic workout program settings.

Note: Changing the batteries will erase stored programs.

Retrieving AutoStore Programs

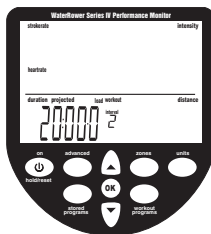

1. Press the **Stored Programs** button *once*.
2. The historic sequence of workouts (1-9) will appear in the program window.
3. The Monitor will automatically scroll through the workout settings.
4. When the desired workout is highlighted, press the **OK** button. Row.

LIMITED WARRANTY

WHAT THIS WARRANTY COVERS

In-Home and Commercial Use – WaterRower (US) Inc. (“WATERROWER”) will replace or repair at its factory or nominated service facility any WaterRower Rowing Machine (“the Product”) found to be defective in material or workmanship for a period of ONE (1) YEAR from the date of initial shipment of the Product by WATERROWER. This Limited Warranty is upgradeable to THREE (3) YEARS on all components (excluding touchscreen electronics, electronics accessories, and rechargeable batteries) and FIVE (5) YEARS on the structural frame by registering the Product within the first year of purchase.

WATERROWER warrants against defects in material or workmanship for touchscreen electronics, electronics accessories, and rechargeable batteries received from WATERROWER or any of its authorized dealers for a period of ONE (1) YEAR after the date of shipment.

WATERROWER warrants against any replacement WaterRower spare part received from WATERROWER or any of its authorized dealers for a period of NINETY (90) DAYS after the date of shipment.

This Limited Warranty applies to the initial purchasers of the Product or spare part(s) ONLY and is not transferable to any other party.

HOW CAN A CUSTOMER OBTAIN WARRANTY SERVICE?

A customer making a warranty claim is responsible to return the defective Product or component(s) to WATERROWER’s factory or its nominated service center, prepaying all postage or other shipping charges. The Product or component must be returned to your nearest WATERROWER office or nominated service center (see www.waterrower.com/us/support/contact). The customer must first notify WATERROWER of their intent to return the Product or component(s) and receive a confirmation from WaterRower before the Product or component(s) are returned.

CLAIMANT'S RESPONSIBILITIES

A claimant must ensure that the defective Product or component(s) are properly packed to protect the item(s) from damage during shipping. WATERROWER will not be responsible for any damage that occurs to the Product or component(s) during shipment.

WHAT WATERROWER WILL DO

WATERROWER will review, repair, or replace the Product or component(s) at WATERROWER's discretion. WATERROWER will then return the repaired or replaced Product or component(s) to the claimant at WATERROWER's expense. WATERROWER will ground / economy ship all replacement warranty Products or components to claimant. Charges will apply for any alternative shipping methods requested by claimant. Product shipped outside of its initial purchase country may be subject to additional shipping costs. Where the product warranty has been deemed void, the costs of repair and any associated shipping costs shall be borne by the claimant. WATERROWER will contact the claimant prior to returning the repaired Product or component(s).

WHEN THIS LIMITED WARRANTY WILL BE VOID

This Limited Warranty will be void if the claim has resulted from: (a) improper assembly of the Product; (b) usage of the Product beyond its design; (c) overfilling of the Product's water tank, as explained in the WaterRower Owner's Manual; (d) use of a purification product in the water tank that is not WATERROWER-approved; (e) use of improper cleaning materials, as described in the preventative maintenance steps in the WaterRower Owner's Manual; (f) use and / or storage of the Product in inclement weather, including (but not limited to) extreme temperatures and moisture; (g) accident, abuse, misuse, misapplication, or as a result of any modification other than that authorized by WATERROWER; and (h) improper preventative maintenance steps as described in the WaterRower Owner's Manual.

RESTRICTIONS - DURATION OF IMPLIED WARRANTIES

The term of any implied warranty, including (but not limited to) any implied warranty of merchantability or fitness for a particular purpose that may arise under your country, province, or state law is limited to the term of the express Limited Warranty in the first paragraph, above. Some states (countries and provinces) do not allow limitations on how long an implied warranty lasts, so the above limitation may not apply to you.

RESTRICTIONS - OTHER DAMAGES

WATERROWER shall not be liable for any direct, consequential, incidental, indirect, or special damages under this Limited Warranty (or any implied warranty) that may arise under your country, province, or state law. Some states (countries and provinces) do not allow the exclusion or limitation of incidental or consequential damages, so the above limitation or exclusion may not apply to you.

Any dispute arising from the terms of this Limited Warranty must be resolved in a court within the state of Rhode Island, USA.

Additional information on parts, assembly, preventative maintenance, and manuals (as referred to within this Limited Warranty) can be found at www.waterrowerservice.com.

This page intentionally left blank.



If you have any questions or comments about the assembly or use of your rower, please contact support@waterrower.com or visit www.waterrowerservice.com.